



REPLACEMENT POWER SUPPLY KIT

for RPM3

PN 402117

Installation Instructions

REPLACEMENT POWER SUPPLY KIT, P/N 402117, INCLUDES:

QTY	PART NO	DESCRIPTION
1	103501	Artesyn® Power Supply, +5V, +12V
1	402299	PROM, 68302 BIOS Mini-Micro
5	100739-Z	Washer, Flat, M3
2	100969-Z	Washer, External Tooth, M3
6	102464-Z	Washer, Split Lock, M3
2	100984-Z	Screw, PHP, M3 x 6
2	101010-Z	Screw, SHC, M3 x 8
1	101005-Z	Screw, SHC, M3 x 10
2	101006-Z	Screw, SHC, M3 x 12
4	101041-Z	Tie, Cable, 3.9"
2	103513	Spacer, Round, 6 MM x 6
2	103514	Spacer, Round, 6 MM x 3
1	124013	Bracket, Power Supply, RPM3
1	402116	Cable Assembly, AC/DC, RPM3

This is a replacement power supply kit for RPM3. It includes the replacement power supply and a replacement BIOS Prom that must be installed for proper operation.

Some RPM3 products may contain a power supply manufactured by Ault. A bracket, mounting hardware, and replacement AC/DC power cable are provided for conversion to the replacement power supply manufactured by Artesyn®. After the enclosure cover has been removed the installer must identify the power supply (see Figures 1 and 2) and proceed to the appropriate section for removal and installation.

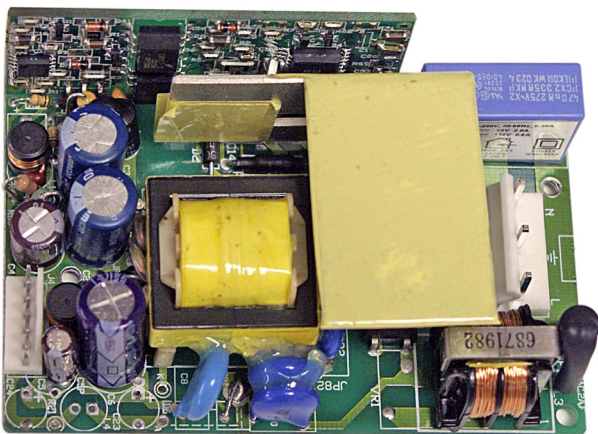

Figure 1. Top View - Ault Power Supply

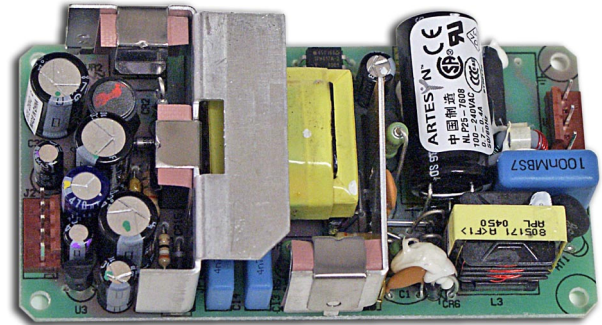

Figure 2. Top View - Artesyn® Power Supply

REMOVE AND REPLACE ARTESYN® POWER SUPPLY AND BIOS:

- ❶ Disconnect power cord.
- ❷ Remove enclosure cover from unit (disconnect fan cable prior to completely removing cover).
- ❸ Detach AC cable and DC cable from power supply.
- ❹ The power supply is mounted in four (4) places with a stainless steel screw, flat washer, lock washer and aluminum spacer. Remove the screws, flat washers and lock washers and remove the power supply board from the chassis.
- ❺ Remove and discard the EPROM BIOS IC.
- ❻ Installation is the reverse of removal.

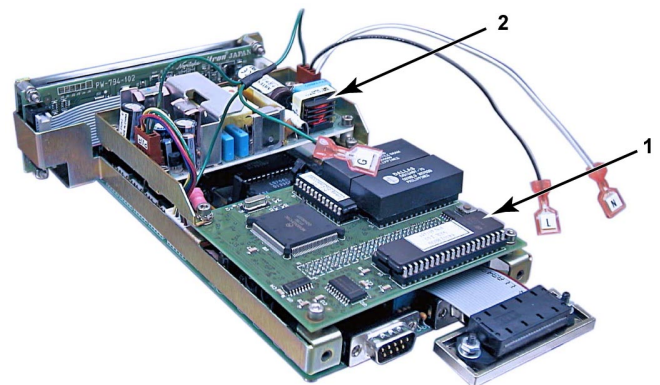

Figure 3. Bios Prom and Power Supply Location

1. BIOS IC
2. Power Supply



NOTE: Installer must be properly grounded when handling BIOS IC.

REMOVE AULT POWER SUPPLY, AND INSTALL ARTESYN® POWER SUPPLY AND BIOS:

- ❶ Disconnect power cord.
- ❷ Remove enclosure cover from unit (disconnect fan cable prior to completely removing cover).
- ❸ Remove chassis from enclosure base (lift straight out).
- ❹ Remove and discard the stainless steel screw and lock washer that secures the AC/DC cable ground lug to the Mini Micro board.
- ❺ Remove the cable ties that secure the AC/DC cable (PN 402060). Detach the AC/DC cable from the power supply, main board and AC receptacle. Discard the AC/DC cable Assembly.
- ❻ The power supply is mounted in three (3) places with a stainless steel screw, a nylon screw, nylon washers and a locking plastic standoff (see Figures 4 and 5).

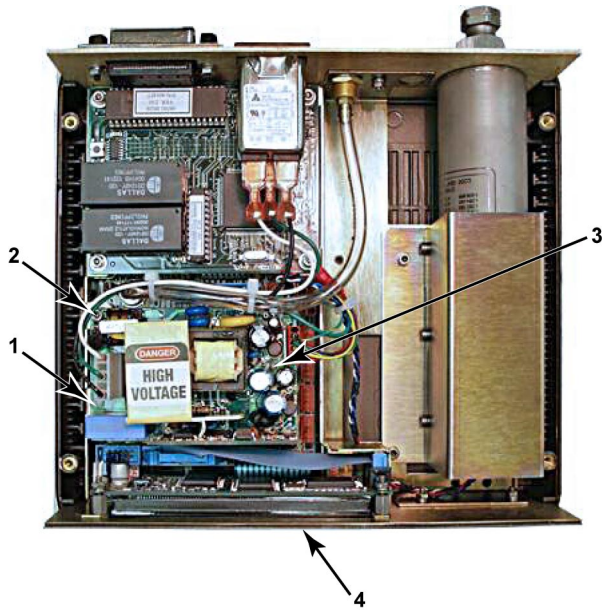

Figure 4. RPM3 Top View

- | | |
|--------------------------|---------------------|
| 1. Nylon Screw | 3. Plastic Standoff |
| 2. Stainless Steel Screw | 4. Front of Unit |

- Ⓐ Remove the stainless steel screw and lock washer, and discard.
- Ⓑ Remove and discard the nylon screw.
- Ⓒ Turn the chassis on its side to access the bottom of the main PCB.
- Ⓓ Locate the tabs of the plastic standoff and squeeze them together to release the standoff from the main board. The power supply can now be removed and discarded.



It is not necessary to remove the plastic standoff from the old power supply

- Ⓔ Remove and discard the nylon washers located between the metal mounting tabs and the power supply.

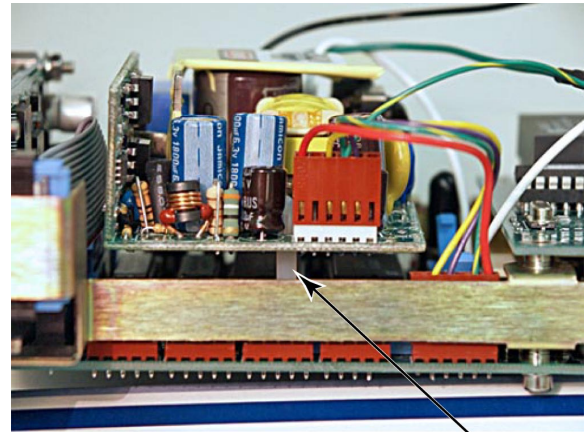

PLASTIC STANDOFF

Figure 5. Right Side View

- ❼ Attach the new mounting bracket to side rail 2 places using the M3 x 6 pan head screw and M3 lock washer. (See figure 7)
- ❼ Fasten the new mounting bracket and the AC/DC Cable Assembly grounding lug to the Mini-Micro board using the M3 x 10 screw, M3 flat washer, and two M3 external tooth lock washers (see Figure 7).
- ❼ Fasten the new power supply to the bracket using the hardware shown in Figure 6.

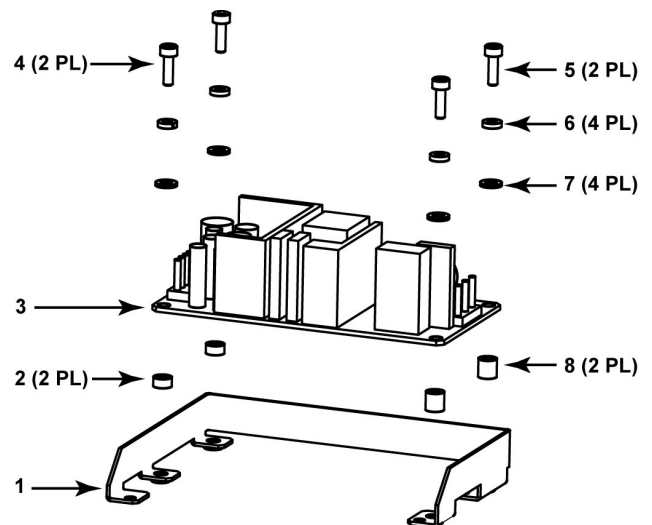

Figure 6. Power Supply Assembly Hardware

- | | |
|------------------------|----------------------|
| 1. 124013 Bracket | 5. M3 x 12 mm Screw |
| 2. Spacer, 3 mm Long | 6. M3 Lock Washer |
| 3. 103501 Power Supply | 7. M3 Flat Washer |
| 4. M3 x 8 mm Screw | 8. Spacer, 6 mm Long |

⑩ Install new AC/DC cable (see Figure 7). The AC connector plug (3-wire) must be installed to the Power Supply connector marked J1 adjacent to the outer side rail. The DC plug (5-wire) connects to Power Supply connector J2. The DC Plug (4 wire) connects to the Main Board connector marked P1. The remaining 3 single wire slip-on connectors attach to the AC receptacle on the rear panel as shown in Figure 8.

- ⑪ Install the new BIOS PROM (see Figure 3)
- ⑫ Place the chassis into the enclosure base.
- ⑬ Assemble enclosure cover to base by first reconnecting the fan cable, then close cover and install cover screws.

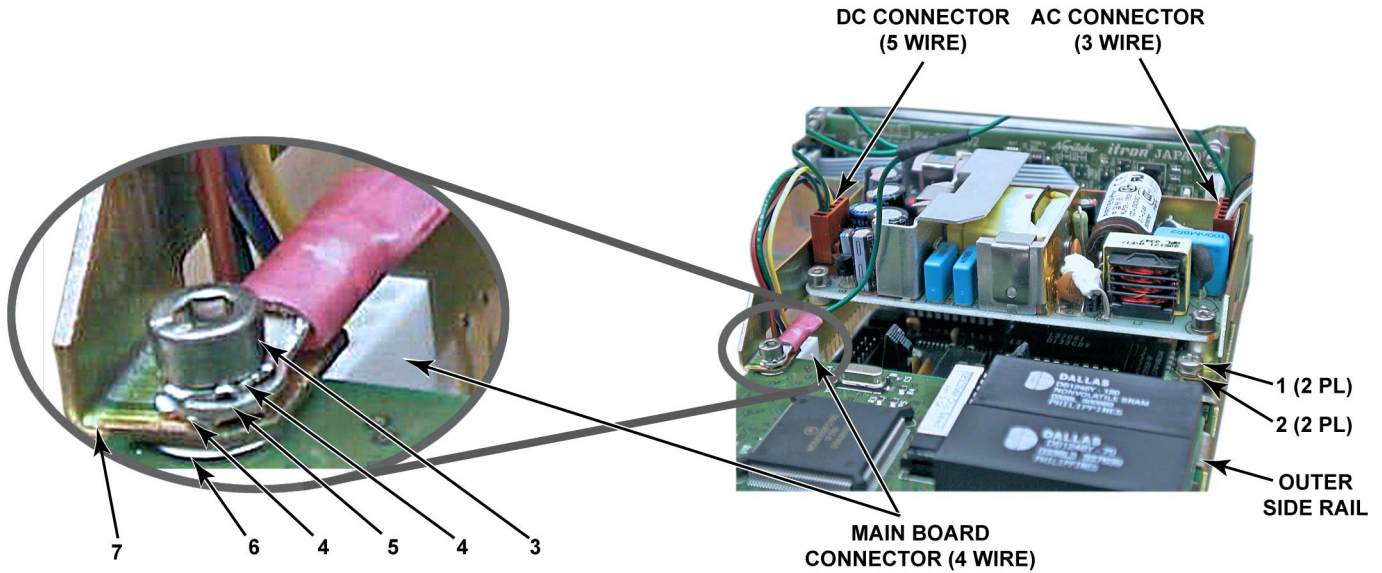

Figure 7. Power Supply Assembly Detail

- | | |
|-------------------------------|------------------------------|
| 1. Screw, SS, M3 x 6 | 5. Cable Assembly Ground Lug |
| 2. Washer, SS, Split Lock, M3 | 6. Washer, Flat, M3 |
| 3. Screw, M3 x 10 | 7. 124013 Bracket |
| 4. External Tooth Lock Washer | |

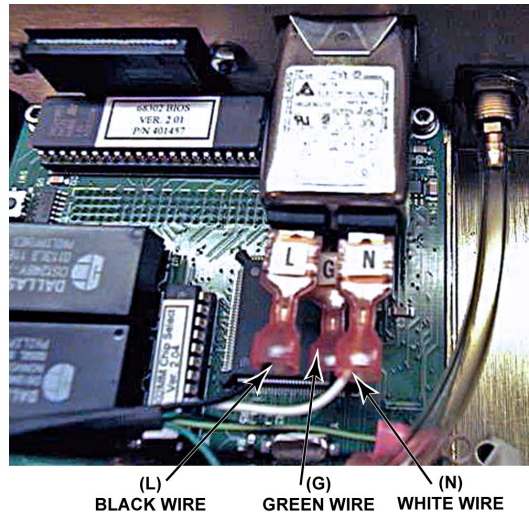

Figure 8. Cable Assembly AC Receptacle Connections

RPM3 and molbox RFM are trademarks, registered and otherwise, of DH Instruments, Inc.