

**RPM4/HPMS A70M/A20M-AF™  
Reference Pressure Monitor with  
High Pressure Mounting System  
Operation and Maintenance Manual**

**NSN 6685-01-529-6990 RN  
(2 of 3)**



High pressure liquids and gases are potentially hazardous. Energy stored in these liquids and gases can be released unexpectedly and with extreme force. High pressure systems should be assembled and operated only by personnel who have been instructed in proper safety practices.

---



This instrument is not to be operated in any other manner than that specified by the manufacturer.

---

© 2007 DH Instruments, a Fluke Company All rights reserved.

Information in this document is subject to change without notice. No part of this document may be reproduced or transmitted in any form or by any means, electronic or mechanical, for any purpose, without the express written permission of **DH Instruments, a Fluke Company** 4765 East Beautiful Lane, Phoenix AZ 85044-5318, USA.

**DH Instruments** makes sincere efforts to ensure accuracy and quality of its' published materials; however, no warranty, expressed or implied, is provided. **DH Instruments** disclaims any responsibility or liability for any direct or indirect damages resulting from the use of the information in this manual or products described in it. Mention of any product or brand does not constitute an endorsement by **DH Instruments** of that product or brand. This manual was originally composed in English and was subsequently translated into other languages. The fidelity of the translation cannot be guaranteed. In case of conflict between the English version and other language versions, the English version predominates.

Products described in this manual are manufactured under international patents and one or more of the following U.S. patents: 5,142,483; 5,257,640; 5,331,838; 5,445,035. Other U.S. and international patents pending.

AutoRange, AutoZ, **DH Instruments, DH, DHI, CalTool, COMPASS, GPC1-1000, PGC-1000-AF, RPM4, QDUT, Q-RPT, RPM4** and SDS are trademarks, registered and otherwise, of **DH Instruments, a Fluke Company**.

Document No. 550136b-01  
070627  
Printed in the USA

# TABLE OF CONTENTS



<b>TABLE OF CONTENTS .....</b>	<b>I</b>
<b>TABLES .....</b>	<b>V</b>
<b>FIGURES.....</b>	<b>VI</b>
<b>ABOUT THIS MANUAL .....</b>	<b>VII</b>
<b>1. INTRODUCTION .....</b>	<b>1</b>
1.1 PRODUCT OVERVIEW .....	1
1.2 SPECIFICATIONS .....	2
1.2.1 GENERAL SPECIFICATIONS.....	2
1.2.2 PRESSURE MEASUREMENT SPECIFICATIONS .....	3
1.2.2.1 QUARTZ REFERENCE PRESSURE TRANSDUCERS (Q-RPT).....	3
1.2.2.2 ON-BOARD BAROMETER .....	3
<b>2. INSTALLATION .....</b>	<b>5</b>
2.1 UNPACKING AND INSPECTION .....	5
2.1.1 REMOVING FROM PACKAGING .....	5
2.1.2 INSPECTING CONTENTS.....	6
2.2 PGC-10000-AF SYSTEM.....	6
2.3 SITE REQUIREMENTS.....	7
2.4 SETUP .....	8
2.4.1 PREPARING FOR OPERATION .....	8
2.4.2 RPM4/HPMS FRONT, REAR AND SIDE VIEWS.....	8
2.4.2.1 RPM4/HPMS FRONT VIEW .....	8
2.4.2.2 RPM4/HPMS REAR VIEW .....	9
2.4.2.3 RPM4/HPMS SIDE VIEW .....	10
2.4.3 RPM4 FRONT AND REAR PANELS .....	10
2.4.3.1 RPM4 FRONT PANEL .....	10
2.4.3.2 RPM4 REAR PANEL.....	11
2.4.4 POWER CONNECTION.....	11
2.4.5 FOOTSWITCH CONNECTION .....	11
2.4.6 TEST PORT CONNECTION .....	11
2.4.6.1 THE ATM PORTS OF RPM4 .....	12
2.4.7 CHECK/SET SECURITY LEVEL.....	12
2.4.8 SETTING UP AUTOTEST FILES .....	12
2.5 POWER-UP AND VERIFICATION.....	13
2.5.1 SWITCH POWER ON .....	13
2.5.2 CHECK PRESSURE MEASUREMENT OPERATION .....	13
2.5.2.1 CHECKING ABSOLUTE MODE PRESSURE MEASUREMENT.....	13
2.5.2.2 CHECKING GAUGE MODE PRESSURE MEASUREMENT .....	13
2.6 SHORT TERM STORAGE .....	14
2.7 LONG TERM STORAGE AND/OR PREPARATION FOR SHIPPING .....	14
<b>3. OPERATION.....</b>	<b>15</b>
3.1 USER INTERFACE.....	15
3.1.1 MAIN RUN SCREEN.....	15
3.1.2 FUNCTION / DATA KEYPAD LAYOUT AND PROTOCOL.....	17
3.1.3 REMOTE [ENT] (ENTER) FOOTSWITCH.....	18
3.1.4 SOUNDS .....	18

<b>3.2</b>	<b>GENERAL OPERATING PRINCIPLES</b> .....	<b>18</b>
3.2.1	PRESSURE READY/NOT READY .....	18
3.2.2	GAUGE MODE, DYNAMIC COMPENSATION FOR ATMOSPHERIC PRESSURE .....	19
3.2.3	MULTI RANGES (Q-RPTS, AUTORANGE AND INFINITE RANGING) .....	19
3.2.4	AUTOMATED TEST AND CALIBRATION SEQUENCES .....	20
3.2.5	HPMS (HIGH PRESSURE MOUNTING SYSTEM) .....	20
3.2.6	DIRECT FUNCTION KEYS SUMMARY .....	24
<b>3.3</b>	<b>DIRECT FUNCTION KEYS</b> .....	<b>24</b>
3.3.1	[RANGE] .....	24
3.3.2	[UNIT].....	26
3.3.3	[MODE] .....	27
3.3.4	[AUTORANGE].....	27
3.3.5	[LEAK CK] .....	29
3.3.6	[DISPLAY].....	31
3.3.6.1	AVG (AVERAGE) .....	32
3.3.6.2	RATE .....	33
3.3.6.3	DEV (DEVIATION) .....	34
3.3.6.4	RPT .....	35
3.3.6.5	HI/LO .....	36
3.3.6.6	FREEZE .....	37
3.3.6.7	CLEAN .....	37
3.3.7	[HEAD].....	38
3.3.8	[SDS].....	39
3.3.9	[AUTOZ].....	39
3.3.9.1	[AUTOZ] IN GAUGE MODE .....	39
3.3.9.2	[AUTOZ] IN ABSOLUTE MODE .....	40
3.3.10	[ENT] (RUN AUTOTEST) .....	43
3.3.10.1	AUTOTEST INITIALIZATION .....	44
3.3.10.2	TEST EXECUTION .....	45
<b>3.4</b>	<b>[SETUP]</b> .....	<b>47</b>
3.4.1	<1RANGE> .....	47
3.4.1.1	SAVING AN AUTORANGE RANGE .....	47
3.4.1.2	DELETING AUTORANGE RANGES .....	48
3.4.2	<2RES> (RESOLUTION).....	48
3.4.3	<3STAB>.....	49
3.4.4	<4UL> (UPPER LIMIT) .....	50
3.4.4.1	OVER PRESSURE FUNCTION .....	50
3.4.5	<5ATEST>.....	51
3.4.5.1	DATA .....	51
3.4.5.2	FILE .....	52
<b>3.5</b>	<b>[SPECIAL]</b> .....	<b>54</b>
3.5.1	<1AUTOZ> .....	55
3.5.1.1	EDIT AUTOZ .....	58
3.5.2	<2REMOTE> .....	58
3.5.2.1	<1COM1, 2COM2> .....	59
3.5.2.2	<3IEEE-488> .....	59
3.5.2.3	<4FORMAT> .....	59
3.5.2.4	<5RS232 SELF-TEST> .....	59
3.5.3	<3HEAD> .....	60
3.5.4	<4SDS> .....	60
3.5.5	<5PREFS> .....	60
3.5.5.1	<1SCRSVR> .....	61
3.5.5.2	<2SOUND> .....	61
3.5.5.3	<3TIME>.....	62
3.5.5.4	<4ID>.....	62
3.5.5.5	<5LEVEL> (SECURITY) .....	63
3.5.6	<6PUNIT>.....	65
3.5.7	<7INTERNAL> .....	66
3.5.7.1	<1BARO> .....	67
3.5.7.2	<2READRT> .....	67
3.5.7.3	<3RPT2X>.....	68
3.5.7.4	<4LO VNT> .....	68
3.5.7.5	<5LOG>.....	68
3.5.8	<8CAL> .....	69
3.5.9	<9RESET> .....	69
3.5.9.1	<1SETS> .....	69
3.5.9.2	<2 UNITS> .....	70
3.5.9.3	<3ATEST>.....	70
3.5.9.4	<4 CAL> .....	71
3.5.9.5	<5 ALL>.....	71

<b>4.</b>	<b>REMOTE OPERATION .....</b>	<b>73</b>
4.1	OVERVIEW .....	73
4.2	INTERFACING.....	73
4.2.1	RS232 INTERFACE.....	73
4.2.1.1	COM1.....	73
4.2.1.2	IEEE-488.....	74
4.2.1.3	COM2.....	74
4.3	PROGRAMMING FORMATS.....	74
4.3.1	CLASSIC PROGRAM MESSAGE FORMAT .....	75
4.3.2	ENHANCED PROGRAM MESSAGE FORMAT .....	75
4.3.2.1	USING COMMAND TYPE COMMANDS .....	75
4.3.2.2	USING QUERY TYPE COMMANDS.....	76
4.4	COMMANDS.....	77
4.4.1	PROGRAMMING MESSAGES.....	77
4.4.2	ERROR MESSAGESS.....	78
4.4.3	PROGRAM MESSAGE DESCRIPTION OVERVIEW.....	79
4.4.4	PROGRAM MESSAGE DESCRIPTIONS.....	80
4.5	STATUS REPORTING SYSTEM .....	97
4.5.1	ERROR QUEUE.....	97
4.5.2	STATUS BYTE REGISTER.....	98
4.5.3	STANDARD EVENT REGISTER.....	99
4.5.4	READY STATUS REGISTER .....	100
4.6	IEEE STD. 488.2 COMMON AND STATUS PROGRAM MESSAGES .....	101
4.6.1	PROGRAM MESSAGE DESCRIPTIONS.....	101
<b>5.</b>	<b>MAINTENANCE, ADJUSTMENTS AND CALIBRATION .....</b>	<b>105</b>
5.1	OVERVIEW .....	105
5.2	RPM4 MAINTENANCE.....	105
5.2.1	AUTOZERO OF Q-RPTS.....	105
5.2.1.1	GAUGE MODE AUTOZERO.....	105
5.2.1.2	ABSOLUTE MODE AUTOZERO .....	106
5.2.2	ADJUSTMENT OF THE ON-BOARD BAROMETER.....	106
5.3	RPM4 Q-RPT CALIBRATION.....	107
5.3.1	PRINCIPLE .....	107
5.3.1.1	PA AND PM COEFFICIENTS .....	107
5.3.1.2	AS RECEIVED AND AS LEFT DATA .....	108
5.3.2	EQUIPMENT REQUIRED.....	108
5.3.3	SET-UP AND PREPARATION .....	109
5.3.4	RECOMMENDED CALIBRATION POINT SEQUENCE .....	110
5.3.5	TURNING OFF ABSOLUTE MODE CAPABILITY FOR A Q-RPT .....	110
5.3.6	Q-RPT CALIBRATION USING CALTOOL FOR Q-RPTS SOFTWARE.....	111
5.3.7	EDITING AND VIEWING Q-RPT CALIBRATION INFORMATION .....	111
5.3.8	Q-RPT ADJUSTMENT WITHOUT CALTOOL FOR Q-RPTS SOFTWARE.....	112
5.4	RPM4 REPAIR.....	114
5.4.1	REMOVING RPM4 FROM HPMS.....	114
5.4.2	OPENING AND CLOSING THE RPM4 ENCLOSURE.....	115
5.4.3	RELOADING EMBEDDED SOFTWARE INTO FLASH MEMORY .....	115
5.4.4	SUBASSEMBLY DESCRIPTION AND LOCATION.....	116
5.4.4.1	MICRO BOARD.....	116
5.4.4.2	POWER SUPPLY MODULE .....	117
5.4.4.3	DRIVER BOARD .....	117
5.4.4.4	ON-BOARD BAROMETER .....	117
5.4.4.5	Q-RPT MODULE .....	117
5.4.4.6	DISPLAY .....	117
5.4.4.7	COOLING FAN.....	118
5.4.5	Q-RPT MODULE PNEUMATIC SCHEMATIC.....	118
5.5	RPM4 ILLUSTRATED PARTS BREAKDOWN .....	118
5.6	HPMS MAINTENANCE.....	124
5.6.1	HPMS OVERHAUL.....	124
5.7	HPMS ILLUSTRATED PARTS BREAKDOWN .....	125

**6. TROUBLESHOOTING ..... 129**

**7. APPENDIX ..... 133**

    7.1 UNIT CONVERSION..... 133

        7.1.1 PRESSURE..... 133

**8. WARRANTY ..... 135**

    8.1 OVERVIEW ..... 135

**9. GLOSSARY ..... 137**

# TABLES



Table 1. RPM4/HPMS A70M/A20M-AF Parts List.....	6
Table 2. Settings and what they are specific to (range, measurement mode, Q-RPT, system).....	20
Table 3. Summary of RPM4 function key operation .....	24
Table 4. Settings made by AutoRange .....	28
Table 5. AutoZ ON and OFF .....	56
Table 6. Security levels .....	64
Table 7. UNIT function - available units of measure.....	66
Table 8. READRT - display update rates.....	68
Table 9. Reset – Sets.....	70
Table 10. Reset – Cal .....	71
Table 11. Reset – All.....	71
Table 12. COM1 pin designations and connections .....	73
Table 13. COM2 DB-9F pin designations .....	74
Table 14. Program message list .....	77
Table 15. Error #s and descriptions .....	78
Table 16. 8 Bit status byte register .....	98
Table 17. 8 bit standard event register .....	99
Table 18. 8 bit ready status register.....	100
Table 19. Program message list .....	101
Table 20. Calibration point sequence for A20M and A70M Q-RPTs .....	110
Table 21. RPM4 Front Panel Illustrated Parts Breakdown (see Figure 15).....	118
Table 22. RPM4 Rear Panel Illustrated Parts Breakdown (see Figure 16) .....	119
Table 23. RPM4 Illustrated Parts Breakdown of Display Assembly (see Figure 17).....	120
Table 24. RPM4 Illustrated Parts Breakdown of Internal Assembly (see Figure 18) .....	121
Table 25. RPM4 Illustrated Parts Breakdown of Internal Assembly (see Figure 19) .....	122
Table 26. RPM4 Illustrated Parts Breakdown of Electronic Chassis (see Figure 20) .....	123
Table 27. HPMS Assembly Illustrated Parts Breakdown (see Figure 21 and 22) .....	125
Table 28. Troubleshooting guide .....	129
Table 29. Pressure unit of measure conversion coefficients .....	133
Table 30. DHI Authorized Service Providers .....	135

# FIGURES

Figure 1. Typical PGC-10000-AF installation layout.....	7
Figure 2. RPM4/HPMS front view .....	8
Figure 3. RPM4/HPMS rear view .....	9
Figure 4. RPM4/HPMS side view.....	10
Figure 5. RPM4 front panel.....	10
Figure 6. RPM4 rear panel.....	11
Figure 7. MAIN RUN screen display fields.....	16
Figure 8. Keypad layout .....	17
Figure 9. RPM4/HPMS front view .....	22
Figure 10. HPMS pneumatic schematic.....	23
Figure 11. Status register schematic .....	98
Figure 12. RPM4/HPMS disassembly view .....	115
Figure 13. RPM4 internal view .....	116
Figure 14. Pneumatic schematic of RPM4 Q-RPT Module .....	118
Figure 15. RPM4 Illustrated Parts Breakdown of Front Panel.....	118
Figure 16. RPM4 Illustrated Parts Breakdown of Rear Panel.....	119
Figure 17. RPM4 Illustrated Parts Breakdown of Display Assembly .....	120
Figure 18. RPM4 Illustrated Parts Breakdown of Internal Assembly.....	121
Figure 19. RPM4 Illustrated Parts Breakdown of Internal Assembly.....	122
Figure 20. RPM4 Illustrated Parts Breakdown of Electronic Chassis.....	123
Figure 21. HPMS Schematic.....	126
Figure 22. RPM4/HPMS-AF Assembly .....	127



---

# ABOUT THIS MANUAL



This manual is intended to provide the user with the basic information necessary to operate an RPM4/HPMS A70M/A20M reference pressure monitor with high pressure mounting system. It also includes a great deal of additional information provided to allow you to optimize the use of the instrument and take full advantage of its many features and functions.

Before using the manual, take a moment to familiarize yourself with the Table of Contents structure: Sections 1, 2 and 3 should be read by all first time RPM4 users. Section 3 is most important for those using the local front panel interface but should be read over by all users to familiarize themselves with general RPM4 operating principles. Section 4 is for remote operation from an external computer. Section 5 provides maintenance and calibration information. Section 6 is a quick troubleshooting guide. Use it to troubleshoot unexpected RPM4 behavior based on the symptom of that behavior. Certain words and expressions have specific meaning as they pertain to RPM4. The Glossary, Section 9, is useful as a quick reference for exact definition of specific words and expressions as they are used in the manual.



---

For those of you who “don’t read manuals”, go directly to Section 2.3 to set up your RPM4/HPMS and then go to Section 2.4 for power-up and verification. This will get you up and running quickly with a minimal risk of causing damage to yourself or your new instrument. THEN... when you have questions or start to wonder about all the great features you might be missing, get into the manual!

---



---

RPM4/HPMS A70M/A20M-AF is usually delivered as part of an PGC-10000-AF system which includes a PGC1-10000-AF pneumatic pressure controller and a GB-152-AF gas booster. The PGC1 and the GB-152 have their own Operation and Maintenance Manuals.

---

## Manual Conventions



---

(CAUTION) is used in throughout the manual to identify user warnings and cautions.

---



---

(NOTE) is used throughout the manual to identify operating and applications advice and additional explanations.

---

[ ] indicates direct function keys (e.g., [RANGE]).  
< > indicates RPM4 screen displays (e.g., <1yes>).

## NOTES



# 1. INTRODUCTION

## 1.1 PRODUCT OVERVIEW

RPM4/HPMS A70M/A20M-AF is the combination of an RPM4 A70M/A20M-AF reference pressure monitor and an HPMS High Pressure Mounting System.

RPM4 A70M/A20M-AF is a stand-alone, microprocessor driven, reference pressure monitor intended to accurately measure gas pressure in a variety of pressure calibration, measurement and testing applications. It has been designed to provide very high performance and extensive features combined with maximum versatility, ease of use and durability. RPM4 A70M/A20M-AF covers the range from 0 to 10 000 psi gauge and atmosphere to 10 000 psi absolute using two high accuracy quartz reference pressure transducers (Q-RPTs) and an on-board barometer to measure pressure.

RPM4 A70M/A20M-AF is controlled locally by the operator using its front panel display, keypad and foot pedal or remotely by a computer using ASCII character command strings over its RS-232 and IEEE-488 interfaces.

RPM4 A70M/A20M-AF uses an AutoRange feature to automatically select the most appropriate Q-RPT and to optimize the RPM4 setup to cover the range.

The HPMS mounts the RPM4 at a convenient viewing angle and contains the hardware to isolate the RPM4's low pressure Q-RPT (A20M (3 000 psi)) when the high pressure Q-RPT (A70M (10 000 psi) ) is in use.

RPM4/HPMS A70M/A20M-AF is typically delivered as part of a PGC-10000-AF Pneumatic Gauge Calibrator. The PGC-10000-AF system includes a GPC1-10000-AF pneumatic pressure controller and a GB-152-AF gas booster that have their own Operation and Maintenance Manuals.

## 1.2 SPECIFICATIONS

### 1.2.1 GENERAL SPECIFICATIONS

**Power Requirements:** 85 to 264 VAC, 50/60 Hz, 25 VA max consumption and 12VDC, 1.2 A

**Operating Temperature Range:** 18 to 28 °C

**Storage Temperature Range:** - 20 to 70 °C

**Weight:** 11 kg (22 lb) approx.

**Dimensions:** 23.5 cm H x 29.4 cm W x 37.5 cm D (9.3 in. x 11.6 in. x 14.8 in.)

**Communication Ports** RS232 (COM1, COM2), IEEE-488.2

**Fuses:** 1 A, 250 VAC fuse, 5 x 20 mm, time lag type fuse  
Internal power supply fuse not replaceable by operator: 2.5A, 250 VAC

**Pressure Range:** 0 to 10 000 psi (70 MPa) in gauge mode  
Atmosphere to 10 000 psi (70 MPa) in absolute mode

**Operating Medium:** Any clean, dry, non-corrosive gas

**Pressure Connections:** DH500 female



*DH500 is a gland and collar type fitting for 6mm (1/4 in.) coned and left hand threaded tubes equivalent to AE F250C, HIP HF4, etc.*

---

**Pressure Limits:** Maximum Working Pressure: 10 000 psi (70 MPa)  
Maximum Pressure Without Damage: 12 000 psi (83 MPa)

**When low Q-RPT is connected to pressure:**

Maximum Working Pressure: 3 000 psi (20 MPa)  
Maximum Pressure Without Damage: 3 600 psi (24 MPa)

#### PGC-10000-AF SYSTEM

**Temperature:** Operating: 18 to 28 °C

Storage: -20 to 70 °C

**Relative Humidity:** Operating: 15 to 70%RH (non-condensing)

Storage: 10 to 90%RH (non-condensing)

## 1.2.2 PRESSURE MEASUREMENT SPECIFICATIONS

### 1.2.2.1 QUARTZ REFERENCE PRESSURE TRANSDUCERS (Q-RPT)

RPM4 A70M/A20M is configured with two quartz reference pressure transducers (Q-RPT) modules to measure pressure.

The Q-RPTs can measure absolute and gauge pressure. Gauge pressure is defined by offsetting atmospheric pressure and applying dynamic compensation for atmospheric changes using the on-board barometer (see Section 3.2.2).

<b>Warm Up Time</b>	30 minute temperature stabilization recommended from cold power up.	
<b>Compensated Temperature Range</b>	5 to 35 °C	
<b>Operating Temperature Range</b>	8 to 28 °C	
	<b>A20M Q-RPT</b>	<b>A70M-QRPT</b>
<b>Maximum Range</b>	3 000 psi (20 MPa)	10 000 psi (70 MPa)
<b>Resolution</b>	user adjustable to 1 ppm of Q-RPT maximum or 10 ppm of active AutoRange, whichever is larger,	
<b>Precision<sup>1</sup></b>	± 0.0175 % of reading, or 0.13 psi, whichever is larger	± 0.0175 % of reading, or 0.44 psi, whichever is larger
<b>Predicted Stability<sup>2</sup></b>	± 0.004 of reading	
<b>Measurement Uncertainty<sup>3</sup></b>	± 0.02 % of reading, or 0.15 psi, whichever is larger	± 0.02 % of reading, or 0.5 psi whichever is larger

1. Combined linearity, hysteresis, repeatability.

2. Predicted Q-RPT measurement stability limit (k=2) over one year assuming regular use of AutoZero function. As stability can only be predicted and varies from Q-RPT to Q-RPT, stability for a specific Q-RPT should be established from experience.

3. Maximum deviation of the Q-RPT indication from the true value of applied pressure including precision, predicted one year stability, temperature effect and calibration uncertainty (assumes calibration reference uncertainty of ±0.005% of reading), combined and expanded (k=2) following the ISO "Guide to the Expression of Uncertainty in Measurement".

### 1.2.2.2 ON-BOARD BAROMETER

The measurement uncertainty of the on-board barometer is not significant to RPM4 Q-RPT measurement uncertainty. It is used only to measure small, short term changes in atmospheric pressure to provide dynamic compensation of the Q-RPT's atmospheric pressure offset when in gauge pressure measurement mode (see Section 3.2.2)

Sensor Technology:	Micro-machined silicon
Warm Up Time:	None required
Resolution:	0.1 Pa (0.000015 psi)

## NOTES



---

## 2. INSTALLATION

### 2.1 UNPACKING AND INSPECTION

---



*RPM4/HPMS A70M/A20M-AF is usually delivered as part of an PGC-10000-AF system which includes a GPC1-10000-AF gas pressure controller and a GB-152-AF gas booster.*

---

#### 2.1.1 REMOVING FROM PACKAGING

RPM4/HPMS A70M/A20M-AF is delivered, along with its accessories, in a reusable molded plastic, shipping container with polyurethane inserts to hold it in place.

Remove the RPM4/HPMS A70M/A20M-AF and its accessories from the shipping container and remove each element from its protective plastic bag.



*Retain the shipping container for repacking the RPM4/HPMS A70M/A20M-AF when it is shipped for recalibration or repair.*

---

## 2.1.2 INSPECTING CONTENTS

Check that all items are present and have no visible damage. If damage is noted, report it to your Receiving Department for appropriate action.

A new RPM4/HPMS A70M/A20M-AF includes all items listed in Table 1.

**Table 1.** RPM4/HPMS A70M/A20M-AF Parts List

DESCRIPTION		PART NO.
RPM4/HPMS A70M/A20M-AF Reference Pressure Monitor/High Pressure Mounting System		402192
<b>ACCESSORIES:</b>		
1 ea.	Transport case (with inserts) (used for original shipment)	124198
1 ea.	Foot switch assembly	401613
1 ea.	PGC-10000-AF Documentation Disk including: <ul style="list-style-type: none"> <li>• <b>RPM4/HPMS A70M/A20M-AF Operation and Maintenance Manual, p/n 550136</b></li> <li>• GPC1-10000-AF Operation and Maintenance Manual, p/n 550135</li> <li>• GB-152-AF Operation and Maintenance Manual, p/n 550137</li> </ul>	402189
1 ea.	Calibration Report	550100
1 ea.	Test Report (PGC-10000-AF) (if the RPM4/HPMS is delivered as part of an PGC-10000-AF system)	550138
1 ea.	Power cord (7.5 ft)	100770
1 ea.	General Accessories Disk (white CD) (Important : Includes system support software and documentation)	102987

## 2.2 PGC-10000-AF SYSTEM

RPM4/HPMS A70M/A20M-AF is usually delivered as the reference pressure measurement component of a PGC-10000-AF Pneumatic Gauge Calibrator. The PGC-10000-AF system includes:

- RPM4/HPMS A70M/A20M-AF: Reference pressure monitor and high pressure mounting system used as the pressure measuring reference of the calibration system.
- GPC1-10000-AF: Gas pressure controller used to set and adjust high pressure gas in the calibration system.
- GB-152-AF: Gas booster package used to supply gas pressure up to 10 000 psi (70 MPa) to the GPC1-10000-AF pressure controller.



Each of the three components of the PGC-10000-AF system has its own Operation and Maintenance Manual and individual setup and start up instructions. Figure 1 shows the typical setup configuration of a complete PGC-10000-AF system.

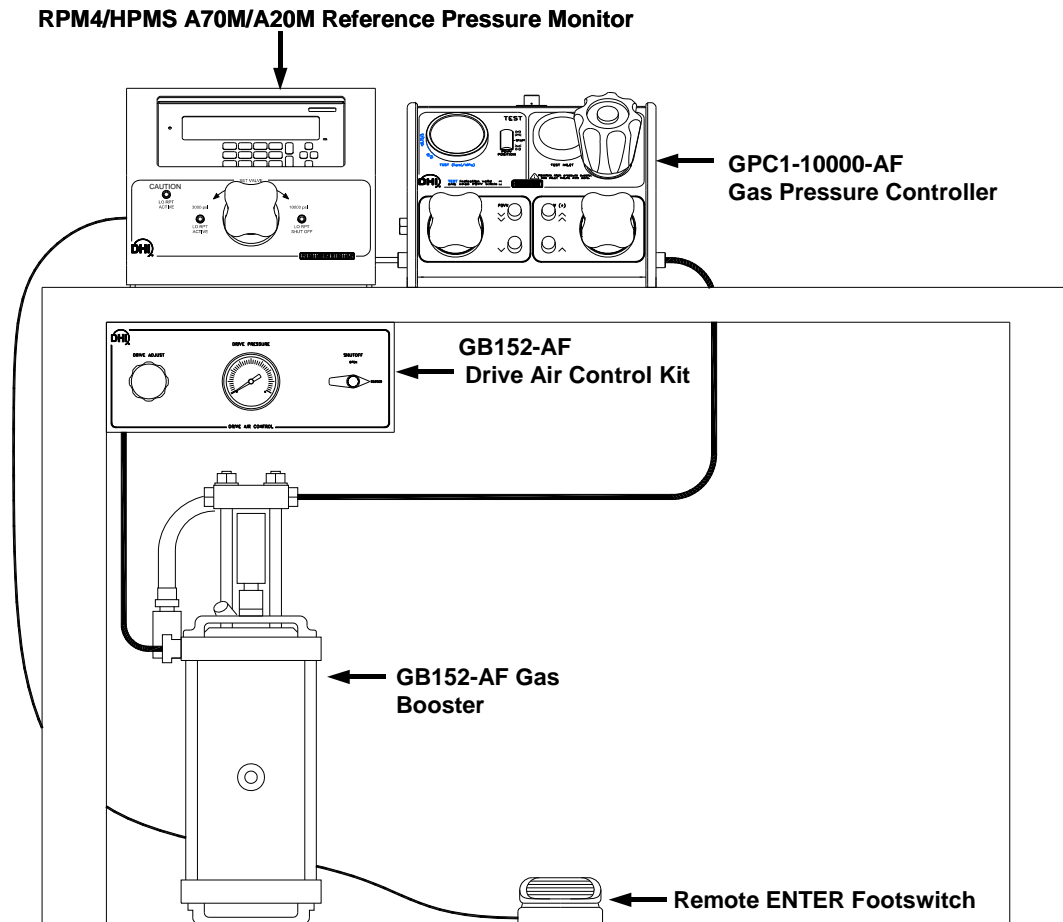

Figure 1. Typical PGC-10000-AF installation layout

## 2.3 SITE REQUIREMENTS

The RPM4/HPMS A70M/A20M-AF is usually delivered as part of an PGC-10000-AF pneumatic gauge calibrator. The PGC-10000-AF also includes a GPC1-10000-AF and a GB-152-AF that each have their own Operation and Maintenance Manual. See the GPC1 and GB-152 Operation and Maintenance Manuals for information on their site requirements. Also see Section 2.2 for information on setup of a complete PGC-10000-AF system.

Install RPM4 on a flat, stable surface at a convenient height. The front feet can be extended so that the unit can be inclined for easier viewing. Consider the placement of the FOOT SWITCH which may need to be accessed frequently while running calibrations.

Support facilities required for RPM4/HPMS A70M/A20M-AF include an electrical power source of 85 to 264 VAC, 47 to 440 Hz.

## 2.4 SETUP

### 2.4.1 PREPARING FOR OPERATION

To prepare RPM4 for check out and operation:

- ❶ Remove the plastic plug from the RPM4/HPMS rear panel TEST connection.
- ❷ Remove the protective plastic sheet from the front panel display.
- ❸ Familiarize yourself briefly with the RPM4 and HPMS front and rear panels (see Sections 2.4.2, 2.4.3).

### 2.4.2 RPM4/HPMS FRONT, REAR AND SIDE VIEWS

#### 2.4.2.1 RPM4/HPMS FRONT VIEW

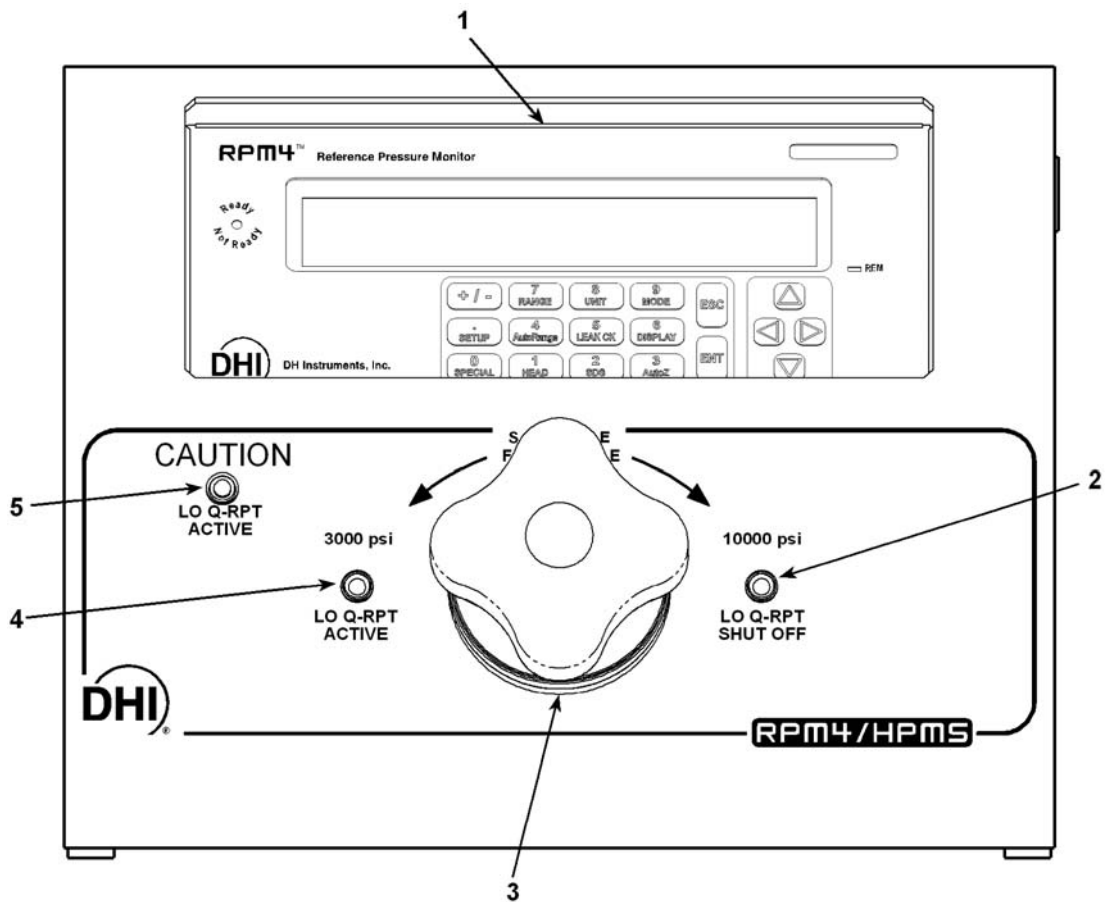

- |   |                                       |
|---|---------------------------------------|
| 1. RPM4 A70M/A20M-AF Reference Pressure Monitor | 4. Lo Q-RPT active valve position LED |
| 2. Lo Q-RPT shut-off valve position LED         | 5. Lo Q-RPT active caution LED        |
| 3. Lo Q-RPT shut-off valve                      |                                       |

Figure 2. RPM4/HPMS front view

2.4.2.2 RPM4/HPMS REAR VIEW

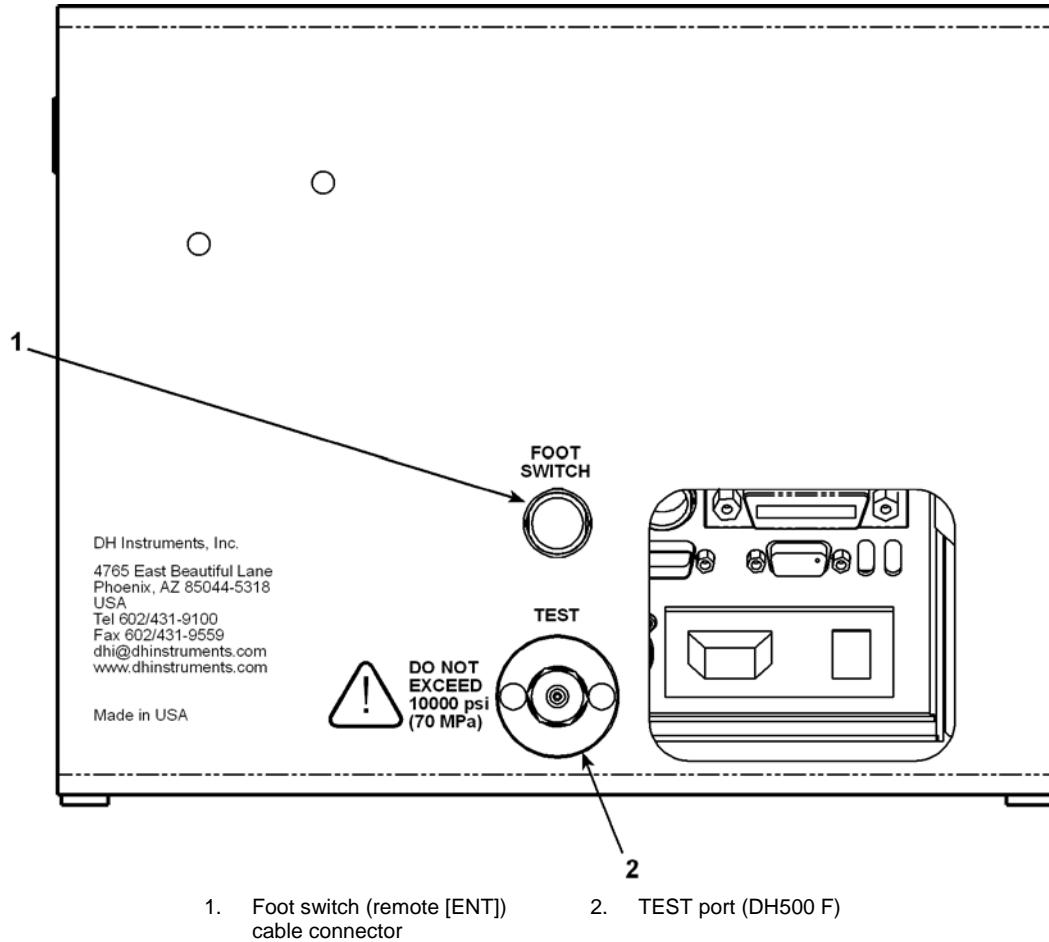
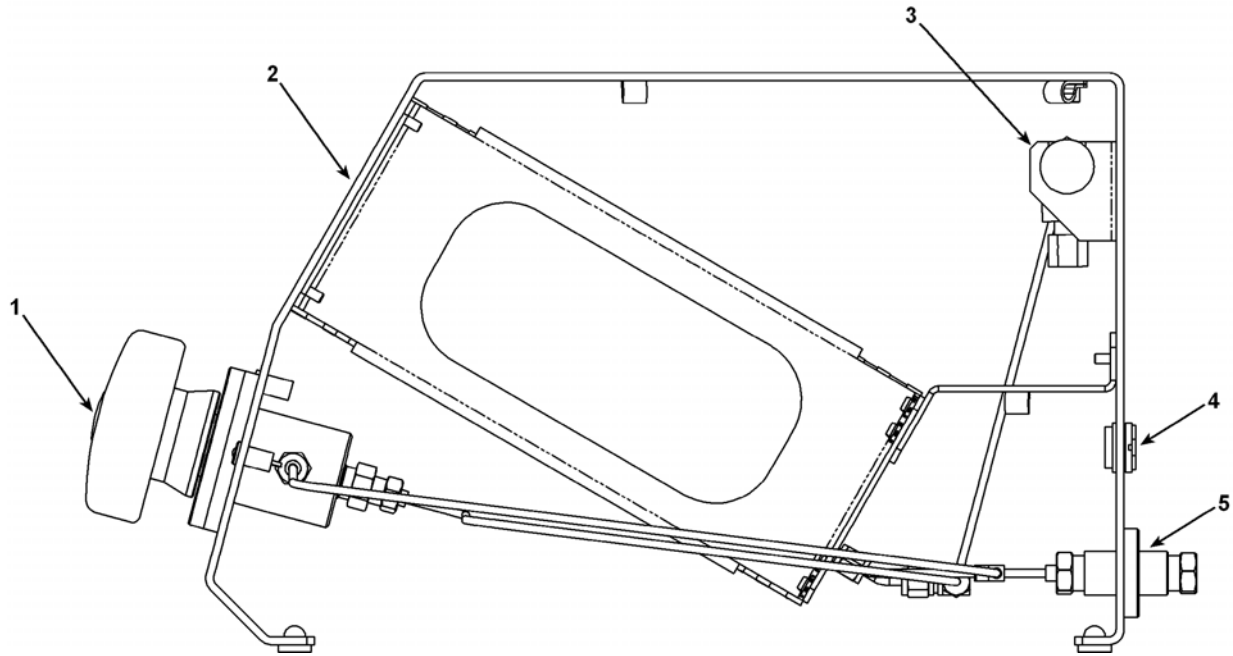

Figure 3. RPM4/HPMS rear view

### 2.4.2.3 RPM4/HPMS SIDE VIEW



- |   |   |
|---|---|
| 1. Lo Q-RPT shut off valve                        | 4. Foot switch (remote [ENT]) cable connector |
| 2. RPM4/HPMS A70M/A20M Reference Pressure Monitor | 5. TEST port (DH500 F)                        |
| 3. Pressure relief valve (3 300 psi)              |   |

Figure 4. RPM4/HPMS side view

## 2.4.3 RPM4 FRONT AND REAR PANELS

### 2.4.3.1 RPM4 FRONT PANEL

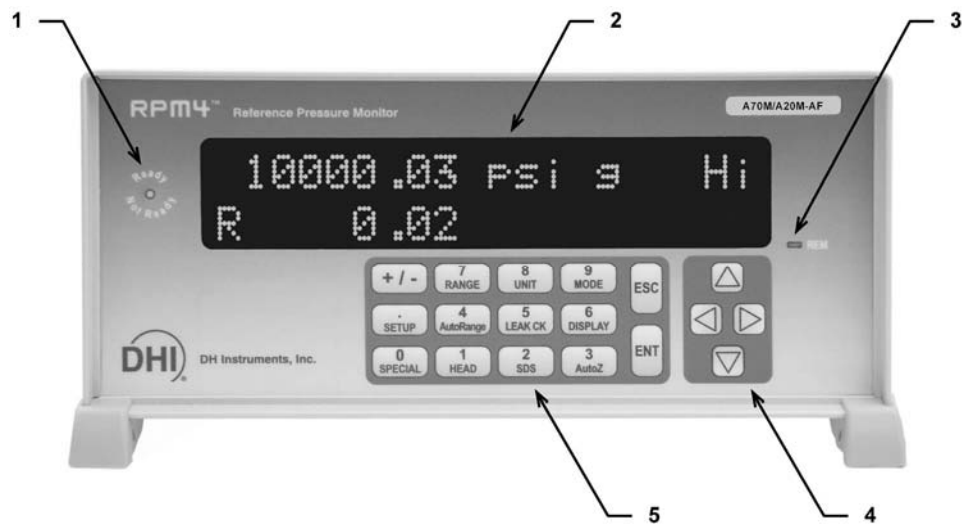

- |                              |                          |
|------------------------------|--------------------------|
| 1. Ready/Not Ready indicator | 4. Cursor control keys   |
| 2. Display                   | 5. Multi-function keypad |
| 3. Remote activity indicator |                          |

Figure 5. RPM4 front panel

## 2.4.3.2 RPM4 REAR PANEL

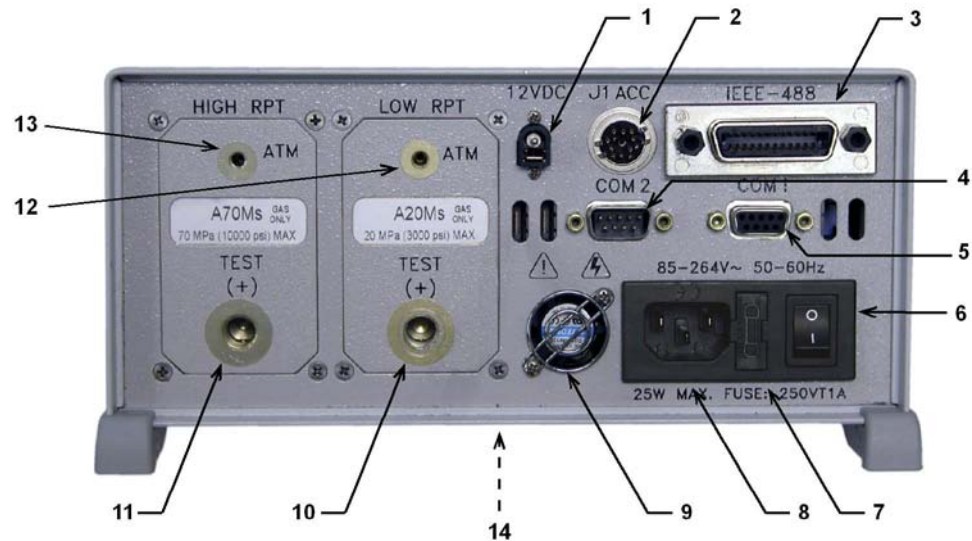

- |   |   |
|---|---|
| 1. 12VDC Power Supply Connection                                  | 8. Electrical Power Connector (IEC-320-C13) |
| 2. Accessories connector (to HPMS rear panel FOOTSWITCH and LEDs) | 9. Fan                                      |
| 3. IEEE-488 Connector   | 10. TEST(+) Pressure Port, Lo Q-RPT         |
| 4. COM2 Connector   | 11. TEST(+) Pressure Port, Hi Q-RPT         |
| 5. COM1 Connector   | 12. ATM Pressure Port, Lo Q-RPT             |
| 6. Power Switch   | 13. ATM Pressure Port, Hi Q-RPT             |
| 7. Fuse   | 14. Product Label (bottom of case)          |

Figure 6. RPM4 rear panel

## 2.4.4 POWER CONNECTION

- ❶ Connect the supplied power cable to the RPM4 rear panel power module.
- ❷ Connect the other end of the power cable to an electrical supply of 85 to 264 VAC, 50/60 Hz.

## 2.4.5 FOOTSWITCH CONNECTION

Connect the foot switch supplied in the RPM4/HPMS accessories to the HPMS rear panel electrical connection labeled **FOOT SWITCH**. Place the foot switch on the floor at a convenient location (see Section 2.2, Figure 1). The FOOT SWITCH function is equivalent to the RPM4 front panel **[ENT]** key and may be used frequently while running tests and calibrations.

## 2.4.6 TEST PORT CONNECTION

A single high pressure TEST port is provided on the rear panel of the HPMS.

The test port connection is a DH500 F. DH500 is a gland and collar type fitting for 1/4 in. (6 mm) coned and left hand threaded tube. DH500 is equivalent to AE F250C, HIP HF4, etc.

**Connection to GPC1 if the RPM4/HPMS is Part of an PGC-10000-AF System**

If the RPM4/HPMS was delivered as part of a PGC-10000-AF Pneumatic Gauge Calibrator, a GPC1 Gas Pressure Controller was delivered with it. The GPC1 includes a fittings kit with the necessary fittings to interconnect the RPM4/HPMS and GPC1 as well as instructions on making the connection. See the GPC1-10000-AF manual.

 **USE THE CORRECT PRESSURE CONNECTORS:** The RPM4/HPMS TEST port fitting is a DH500 F (see Section 1.2.1). It is NOT a 1/8 in. NPT F. Never use a fitting other than the corresponding male fitting in these connectors. Damage to the connectors and dangerous failure under pressure could result from using incorrect fittings.

---

 **DO NOT APPLY PRESSURE UNTIL YOU ARE FAMILIAR WITH OPERATION:** The RPM4/HPMS rear panel test port connects internally to both the RPM4's 3 000 psi (20 MPa) and 10 000 psi (70 MPa) Q-RPTs. The valve on the front of the HPMS isolates the low pressure Q-RPT when the high pressure Q-RPT is in use. Do not apply pressure to the RPM4/HPMS until you are familiar with its operation and know how to protect the low pressure Q-RPT from overpressure (see Section 3.2.5). **FAILURE TO PROTECT THE LOW PRESSURE Q-RPT FROM OVERPRESSURE MAY DESTROY IT. DAMAGE DUE TO Q-RPT OVERPRESSURE IS NOT COVERED BY THE PRODUCT WARRANTY.**

---

#### 2.4.6.1 THE ATM PORTS OF RPM4

The **ATM** ports on the RPM4 Q-RPT modules are connected to the RPM4's internal barometer to assure that the RPM4 gauge pressure measurements are relative to ambient pressure. These ports should always be left completely unobstructed and open to atmosphere.

 **NEVER plug, obstruct or connect a supply pressure to the RPM4 Q-RPT module ATM ports.** This may adversely affect GAUGE mode operation and AutoZeroing functions.

---

#### 2.4.7 CHECK/SET SECURITY LEVEL

RPM4 has a security system based on user levels. By default, the security system is set to "low", which includes access restriction to internal calibration coefficients, and there is no password required to change the security level. See Section 3.5.5.5 for information on the security level system. As part of the RPM4 startup, determine the security level that is appropriate for the RPM4 and set a password if desired.

 **RPM4 is delivered with the security level set to "low" to avoid inadvertent altering of critical internal settings but with access to changing security levels unrestricted.** It is recommended that the low security level be maintained at all times and password protection be implemented if control over setting of security levels is desired.

---

#### 2.4.8 SETTING UP AUTOTEST FILES

RPM4 supports automated test/calibration sequences. AutoTest sequence parameters for testing specific DUTs can be stored in File AutoTest files and recalled to run a test. Consider setting up File AutoTest files for frequently tested DUTs as part of the RPM4 set up process (see Section 3.3.10, 3.4.5.2).

---

## 2.5 POWER-UP AND VERIFICATION

### 2.5.1 SWITCH POWER ON

Actuate the power switch on the RPM4 rear panel. Observe the front panel display as RPM4 initializes, error checks and goes to the MAIN RUN screen (see Section 3.1.1). If the RPM4 fails to reach the main run screen, service is required. Record the sequence of operations and displays observed and contact a **DHI** Authorized Service Provider (see Section 8, Table 23).

Check that one of the two green Valve Status LEDs on the front panel of the HPMS is lit (the red LED should NOT be ON). If neither of the green LEDs on the HPMS front panel lights, check that the 12 pin circular connector at the rear of the RPM4 itself is properly connected to the ACC. J1 connector.

### 2.5.2 CHECK PRESSURE MEASUREMENT OPERATION

#### 2.5.2.1 CHECKING ABSOLUTE MODE PRESSURE MEASUREMENT

Let the RPM4 warm up with power ON for approximately 30 minutes.

Press **[MODE]** on the RPM4 and select absolute. If desired, change the pressure unit of measure using **[UNIT]** (see Section 3.3.2).

Open the RPM4/HPMS TEST port to atmosphere. Put the valve knob in the HPMS front panel into the **Lo Q-RPT Active** position. This opens the Lo and Hi Q-RPTs to the HPMS **TEST** port.

Use **[RANGE]** (see Section 3.3.1) to select the Lo Q-RPT. Observe the RPM4 indicated pressure. Check that the agreement of the RPM4 indicated value with a calibrated barometer in the same room is  $\pm 0.15$  psi. The calibrated barometer must have a measurement uncertainty of  $\pm 0.25\%$  or better.

Use **[RANGE]** to select the Hi Q-RPT. Check that the agreement of the RPM4 indicated value with a calibrated barometer in the same room is  $\pm 0.5$  psi.

If a Q-RPT does not agree within tolerance, it may need to be AutoZeroed (see Section 3.3.9), calibrated (see Section 5.3) or repaired.

#### 2.5.2.2 CHECKING GAUGE MODE PRESSURE MEASUREMENT

Let the RPM4 warm up with power ON for at approximately 30 minutes.

Open the RPM4/HPMS TEST port to atmosphere. Put the valve knob in the HPMS front panel into the **Lo Q-RPT Active** position. This opens the Lo and Hi Q-RPTs to the HPMS **TEST** port.

Use **[RANGE]** (see Section 3.3.1) to select the Lo Q-RPT. Press **[MODE]** on the RPM4 and select gauge. If desired, change the pressure unit of measure using **[UNIT]** (see Section 3.3.3).

The value indicated should be near zero. Press **[AutoZ]**. This runs AutoZ to zero the Q-RPT reading (see Section 3.3.9.1). Upon return to the main run screen, observe that the indication of measured pressure has zeroed.

Use **[RANGE]** to select the Hi Q-RPT and repeat the zeroing process.

If the display fails to zero properly for either Q-RPT, RPM4 may need repair.



*It is normal for RPM4 to indicate a value other than zero when vented when gauge mode is first entered or ranges are changed, especially if AutoZ is OFF, RPM4 has been OFF for some time or its location has changed.*

---

## 2.6 SHORT TERM STORAGE

The following is recommended for short term storage of RPM4/HPMS:

- Vent the RPM4/HPMS TEST port.
- Switch the RPM4 power OFF.

## 2.7 LONG TERM STORAGE AND/OR PREPARATION FOR SHIPPING

The following is recommended for long term storage and or shipping of RPM4/HPMS:

- Plug the HPMS TEST port.
- Place the RPM4/HPMS in a plastic bag.
- Place the RPM4/HPMS in the custom shipping/storage case in which it was delivered.





## 3. OPERATION

### 3.1 USER INTERFACE

RPM4/HPMS is designed to offer the optimum balance between simple, straight forward operation and the availability of a wide variety of functions with a high level of operator discretion if desired.

The local operator interface is through the RPM4 front panel 2 x 20 character alpha-numeric display, a function/data keypad, a cursor control pad, an **[ENTER]** footswitch and a *Ready/Not Ready* indicator. Remote communications are also available via RS-232 or IEEE-488 interfaces (see Section 4).

The HPMS mounts the RPM4 at a convenient viewing angle and includes a valve and visual indicators to isolate and protect the RPM4's 3 000 psi Q-RPT (A20M) when using the 10 000 psi Q-RPT (A70M) (see Section 3.2.5).

#### 3.1.1 MAIN RUN SCREEN

The RPM4 MAIN RUN screen is its home display that is reached on power-up and from which other functions and menus are accessed. It is the very top level of all menu structures.

The MAIN RUN screen is where RPM4 is left in normal operation. It displays the current measured pressure as well as a variety of additional information if desired.

Figure 7 and its legend summarize the RPM4 MAIN RUN screen fields and their functions.



RPM4 has a screen saver function which causes the display to dim if no key is pressed for 10 minutes. Pressing a key restores full power to the display. The screen saver time can be changed or screen saving can be completely suppressed (see Section 3.5.5.1).

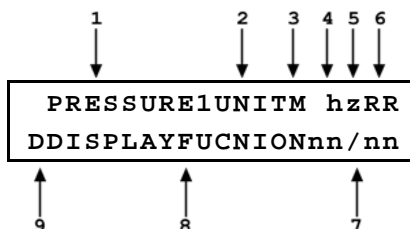

DISPLAY FIELD	NAME	PURPOSE	CONTENTS	SECTION
1. PRESSURE1	Measured pressure	Displays pressure measured by the active Q-RPT	Numerical pressure value and sign.	1.2.2.1, 3.3.1
2. UNIT	Unit of measure	Identifies unit of measure in which pressure values are displayed	Pressure unit symbol	3.3.2
3. M	Measurement mode	Identifies measurement mode of displayed pressure	<a> absolute <g> gauge	3.3.3
4. h	Head pressure indicator	Indicates whether a fluid head correction is applied to PRESSURE1	<h> the fluid head is not zero <blank> fluid head is zero	3.3.7
5. z	AutoZero indicator	Indicates whether the AutoZero function is ON or OFF for the active Q-RPT and measurement mode	<z> AutoZ is ON <blank> AutoZ is OFF	3.5.1, 3.3.9
6. RR	Active Q-RPT position indicator	Indicates the position of the active Q-RPT in the RPM4	<Hi> Internal Hi <Lo> Internal Lo	3.2.3
7. nn/nn	Sequence progress indicator	Indicates progress of an ATest sequence, during test execution	<nn/nn> Number of this point over total number of points in the sequence	3.3.10
8. DISPLAY FUNCTION	Information specific to the DISPLAY mode	Pressure indication depending on current RPM4 DISPLAY function. Leading character identifies the value	Numerical pressure value and sign.	3.3.6
9. D	Pressure information indicator	Pressure information indicator depending on current RPM4 DISPLAY function.	<σ> Display mode is AVERAGE and value is standard deviation <R> Display mode is RATE and value is pressure rate of change per second <H> Display mode is HI/LO and value is high, then low <D> Display mode is DEVIATION and value is difference from current target <<, ↑, ↓ > Display mode is Q-RPT and value is measurement of inactive Q-RPT <F> Display mode is FREEZE and value is last captured reading <b>Blank, no character</b> Current display mode is CLEAN	3.3.6

Figure 7. MAIN RUN screen display fields

### 3.1.2 FUNCTION / DATA KEYPAD LAYOUT AND PROTOCOL

The RPM4 has a function/data keypad for local operator access to direct functions, function menus and for data entry.

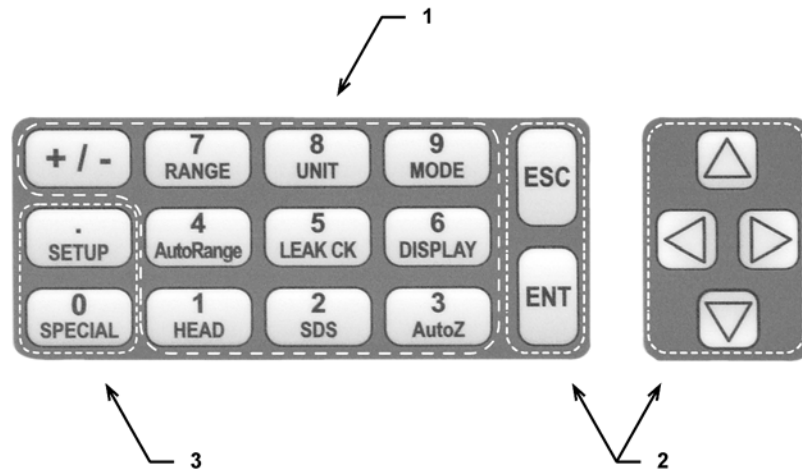

1. The **Function/Data keys** allow very commonly used functions to be accessed directly by a single keystroke when pressed from the MAIN RUN screen (see Section 3.1.1). The name of the function is on the bottom half of the key. These keys enter numerical values when editing.
2. The **Editing and Execution keys** are for starting and suspending command execution, cursor control in menus and editing entries.
3. The **Menu/Data keys** provide access to function menus when pressed from the MAIN RUN screen. The menu name is on the bottom half of the key. The SETUP menu is for more frequently used functions (see Section 3.4). The SPECIAL menu is for functions that are not generally used as a part of day to day operation (see Section 3.5). These keys enter numerical values when editing.

**Figure 8.** Keypad layout

Pressing the **[ENT]** key generally causes execution or forward movement in the menu tree.

Pressing the **[ESC]** key moves back in the menu tree and/or causes execution to cease or suspend. Pressing **[ESC]** repeatedly eventually returns to the MAIN RUN screen and, from there, allows momentary viewing of the RPM4 introduction screen.

Pressing the **[+/-]** key changes a numerical sign when editing. It also toggles through multiple screens when available and, from some run screens, is a shortcut to a momentary display of active RANGE.

Pressing the **[▲]**, **[▼]**, **[◀]** and **[▶]** keys allows up, down, reverse and forward cursor movement when editing data **entry** or moving in menus.



*Some screens go beyond the two lines provided by the display. This is indicated by a flashing arrow in the second line of the display. Press the cursor control keys to move the cursor to access the lines that are not visible or directly enter the number of the hidden menu choice if you know it.*

### 3.1.3 REMOTE [ENT] (ENTER) FOOTSWITCH

Operating the footswitch is the equivalent of pressing [ENT] on the front panel.

The remote ENTER feature can be particularly convenient when running AutoTests (see Section 3.3.10) in which the operator's hands are not free or attention is on the device under test rather than the RPM4.

### 3.1.4 SOUNDS

RPM4 is equipped with a variable frequency tone device to provide audible feedback and alarms. The beeper is used for the following indications.

<b>Valid key press</b>	Brief beep. Choice between three frequencies or NO sound is available (see Section 3.5.5.2).
<b>Invalid key press</b>	Descending two tone "blurb".
<b>Change HPMS Lo Q-RPT shut-off valve setting</b>	Four one second beeps (see Section 3.2.5, 3.3.1).
<b>Leak check completed</b>	Three two second beeps (see Section 3.3.5).
<b>Upper or lower limit exceeded</b>	Intermittent one second beeps (see Section 3.4.4).
<b>Pmax! (overpressure limit) exceeded</b>	Eight second high frequency beep (see Section 3.4.4.1).
<b>Hi Q-RPT is selected but Lo Q-RPT is being pressurized</b>	Intermittent two second high frequency beep. The audible alarm is combined with flashing of the red, <b>Lo Q-RPT Active</b> LED on the HPMS (see Section 3.2.5, 3.3.1).
<b>AutoTest in/out of tolerance reading</b>	Ascending triad/descending triad (see Section 3.3.10).

## 3.2 GENERAL OPERATING PRINCIPLES

### 3.2.1 PRESSURE READY/NOT READY

There is a *Ready/Not Ready* indicator LED on the RPM4 front panel. It is intended to provide the user with a clear and objective indication of when a stable pressure has been achieved. *Ready* is indicated when the current stability (rate of change) of pressure is less than the stability limit. The user can set the stability limit (see Section 3.4.3) and the stability limit can be set automatically by a AutoRange or AutoTest (see Section 3.3.4, 3.3.10). The *Ready* indication is often used when comparing the RPM4 and a test device to indicate when a valid reading can be made.

The *Ready/Not Ready* LED indications are:

<Green >	Pressure <b>Ready</b>	The pressure stability is within the stability limit.
<Red>	Pressure <b>Not Ready</b>	The pressure stability is NOT within the stability limit.

### 3.2.2 GAUGE MODE, DYNAMIC COMPENSATION FOR ATMOSPHERIC PRESSURE

The RPM4 A70M/A20M-AF Q-RPTs are intrinsically absolute but they are also used for gauge measurement mode (see Section 3.3.3, ○ PRINCIPLE). Gauge measurement mode is achieved by subtracting the value of atmospheric pressure,  $P_{\text{offset,G}}$ , from the Q-RPT's absolute reading using AutoZ (see Section 3.2.2). The AutoZ routine that measures  $P_{\text{offset,G}}$ , is run by pressing [AutoZ] whenever RPM4 is in the vented condition. This assures the continuous updating of the  $P_{\text{offset,G}}$  value corresponding to atmospheric pressure. Gauge pressure is the measured absolute pressure,  $P_u$ , minus the atmospheric offset,  $P_{\text{offset,G}}$ .

$$P_{\text{gauge}} = P_u - P_{\text{offset,G}}$$

However, atmospheric pressure may change between opportunities to run AutoZ and update the value of  $P_{\text{offset,G}}$ , for example when running an extended test without venting. RPM4 uses **dynamic compensation for atmospheric pressure** to correct for changes in atmospheric pressure between opportunities to run AutoZ and update  $P_{\text{offset,G}}$ . When AutoZ runs, and  $P_{\text{offset,G}}$  is determined, the reading of RPM4's on board barometer,  $P_{\text{atm,0}}$ , is also recorded. Later, when no longer vented, the change in atmospheric pressure,  $\Delta P_{\text{atm}}$ , since  $P_{\text{offset,G}}$  was updated, is the difference between the current barometer reading,  $P_{\text{atm}}$ , and the barometer reading at the time of AutoZ execution,  $P_{\text{atm,0}}$ :

$$\Delta P_{\text{atm}} = P_{\text{atm}} - P_{\text{atm,0}}$$

Dynamic compensation for atmospheric pressure uses  $\Delta P_{\text{atm}}$  to correct the value of  $P_{\text{offset,G}}$ , thus always compensating real time for changes in atmospheric pressure:

$$P_{\text{gauge}} = P_u - P_{\text{offset,G}} - \Delta P_{\text{atm}}$$

The additional uncertainty in gauge pressure mode due to the dynamic compensation for atmospheric pressure technique is a function of the resolution and short term stability of the on-board barometer, not its absolute measurement uncertainty. This additional uncertainty is completely insignificant in the range of pressure covered by the RPM4 A70M/A20M-AF.

### 3.2.3 MULTIPLE RANGES (Q-RPTS, AUTORANGE AND INFINITE RANGING)

RPM4 A70M/A20M-AF has two Quartz Reference Pressure Transducers (Q-RPTs). The A70M (10 000 psi) Q-RPT is designated the **Hi** Q-RTP. The A20M (3 000 psi) Q-RPT is designated the **Lo** Q-RTP. Which Q-RPT is currently active is continuously by characters in the upper right hand corner of the MAIN RUN screen and most other screens.

Each RPM4 Q-RPT has a default range which is its maximum range. Additional ranges, lower than the Q-RPT's maximum, may also be created using AutoRange and AutoTest (see Section 3.3.4, 3.3.10). Ranges created using AutoRange are temporary but may be saved with all their settings for reactivation (see Section 3.4.1.1).

An RPM4 range is identified by a range screen showing the Q-RPT used by the range, its current unit of measure and its full scale pressure in gauge and absolute measurement modes. The range screen is:

1. Q-RPT designator.
2. Type of range. DF for the Q-RPT's default range; AR for a range created by AutoRange.
3. Q-RPT position designator.
4. Current pressure unit of measure.
5. Full scale pressure in current unit of measure in gauge (<g>) and/or absolute (<a>) measurement mode.

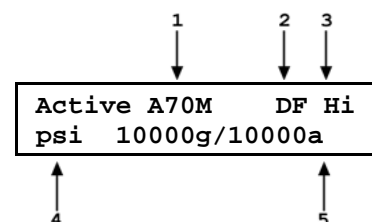

The ranges available on the RPM4 are accessed using **[RANGE]** (see Section 3.3.1) and/or created using **[AutoRange]** (see Section 3.3.4).

Most settings made in an RPM4 range, such as unit of measure, measurement mode, display resolution, and stability setting are specific to the range. Settings selected while one range is active apply to that range and not to other ranges. The range specific settings are stored with the range and recalled whenever the range is made active. This makes setting up ranges a convenient way to store and recall frequently used operating configurations. See Table 2 for a listing of RPM4 adjustments and settings and whether they are range, Q-RPT or system specific.

**Table 2.** Settings and what they are specific to (range, measurement mode, Q-RPT, system)

SETTING	PURPOSE	SPECIFIC TO	SECTION
<b>[UNIT]</b>	Set pressure unit of measure	Range	3.3.2
<b>[MODE]</b>	Set pressure measurement mode (absolute, gauge)	Range	3.3.3
<b>[DISPLAY]</b>	Set bottom line display function	System	3.3.6
<b>[HEAD]</b>	Set fluid head correction height, fluid, unit of measure	System	3.3.7
<b>[AutoZ]</b>	Run AutoZ	Q-RPT and measurement mode	3.3.9
Resolution	Set pressure display resolution	Range	3.4.2
Stability	Set <i>Ready/Not Ready</i> stability test.	Range	3.4.3
Upper Limit (UL)	Set upper limit alarm	Range and measurement mode	3.4.4
AutoZ	AutoZ, ON/OFF, set and view values	Q-RPT and measurement mode	3.5.1
Screen Saver, Sound, Time, ID, Level	Set system user preferences	System	3.5.5
Cal	Various Q-RPT and barometer calibration functions, including turning off absolute and negative gauge modes	Q-RPT or barometer	3.5.8

### 3.2.4 AUTOMATED TEST AND CALIBRATION SEQUENCES

The RPM4 AutoTest function supports “Quick” and “File” automated calibration sequences. These automatically AutoRange the RPM4, setting its resolution, stability limit and upper limit based on the characteristics of the device under test. They also prompt the user through the increments of the calibration sequence and log calibration data. The AutoTest function should be used for most common calibration tasks, especially calibration of analog pressure gauges (see Section 3.3.10).

### 3.2.5 HPMS (HIGH PRESSURE MOUNTING SYSTEM)

The HPMS (high pressure mounting system) holds the RPM4 at a convenient viewing angle and includes a valve and visual indicators to isolate and protect the RPM4’s 2 000 psi (A20M) Q-RPT when using the 10 000 psi (A70M) Q-RPT.

See Figure 10 for an HPMS schematic.

#### ○ OPERATION

Numerical references in this Section refer to Figure 9.

In normal use, the operator’s only interaction with the HPMS is to operate the isolation valve knob to connect and disconnect the Lo Q-RPT from the **TEST** port. The valve’s operation is prompted by the **Valve Position LEDs** (2, 4).

The **Lo Q-RPT isolation valve** (3) isolates and protects the Lo Q-RPT from the **TEST** port when it is closed (knob fully CCW) and opens the Lo Q-RPT to the **TEST** port when it is open (knob fully CW).

The **Valve Position LEDs** (2, 4) indicate the position in which the valve knob should be set based on the current Q-RPT selection on the RPM4. If the Hi Q-RPT is selected, the **LO Q-RPT SHUT OFF** LED (2) is lit indicating that the valve knob should be turned fully CW to close the valve, protecting the Lo Q-RPT from high pressure. If the Lo Q-RPT is selected, the **LO Q-RPT ACTIVE** LED (4) is lit indicating that the valve knob should be turned fully CCW to open the valve, connecting the Lo Q-RPT to the test pressure.



*The HPMS isolation valve (3) must always be in the closed position (knob fully CCW) when operating at pressure greater than 3 000 psi (20 MPa).*

The **CAUTION LO Q-RPT ACTIVE** LED (5) is used to indicate that the Lo Q-RPT is active and provide an alert when the Lo Q-RPT is active but a Hi Q-RPT range is selected on the RPM4.

The **CAUTION LO Q-RPT ACTIVE** LED (5) is driven by the value of pressure currently measured by the Lo Q-RPT, it is not driven by the valve position as there is no sensing of the valve position.

The **CAUTION LO Q-RPT ACTIVE** LED (5) has three possible conditions:

- LED is OFF: The Lo Q-RPT is NOT active. The Lo Q-RPT is considered active when it measures a pressure greater than about 30 psig (200 kPa).
- LED ON continuously: The Lo Q-RPT IS active and the Lo Q-RPT is selected on the RPM4. The LED is lit as a reminder that the Lo Q-RPT is active and pressure over its maximum working pressure of 3 000 psi (20 MPa) should not be applied.
- LED is flashing ON/OFF accompanied by high frequency beeps and <!!LO Q-RPT ACTIVE!!> displayed by RPM4: Lo Q-RPT IS active and the Hi Q-RPT is selected on RPM4. The Lo Q-RPT should NOT be exposed to pressure when the Hi Q-RPT is selected. Exposing the Lo Q-RPT to pressures for which the Hi Q-RPT is normally used, will overpressure and damage the Lo Q-RPT. Vent pressure from the RPM4 and shut off the Lo Q-RPT with the Lo Q-RPT shut off valve before continuing to use the Hi Q-RPT.



*If the Hi RPT is selected with the Lo Q-RPT active, RPM4 goes into an alarm condition to avoid accidental overpressure of the Lo Q-RPT while using a Hi Q-RPT. The pressure on the Lo Q-RPT must be reduced to less than 30 psig (200 kPa) so that the CAUTION LO Q-RPT ACTIVE LED is OFF before shutting the Lo Q-RPT shut off valve and selecting the Hi Q-RPT.*

The **HPMS pressure relief valve (Figure 10, Ref 3)** is set to open at 110 % of the RPM4 Lo Q-RPT maximum range. When the pressure applied to the Lo RPT reaches approximately 3 300 psi (23 MPa), the pressure relief valve will open exhausting gas to atmosphere and reducing pressure. Prior to opening the pressure relief valve, the RPM4 will have gone into an overpressure condition (see Section 3.4.4.1). If an overpressure condition occurs, reduce pressure as soon as possible. The pressure relief valve will reseal automatically and close when pressure is reduced.



*Do NOT overpressure the Lo Q-RPT. The Lo Q-RPT may be damaged beyond repair by pressure greater than 3 300 psi (23 MPa). Q-RPT damage from overpressure is logged in user and factory maintenance pages and is not covered by the product warranty. The HPMS pressure relief valve should only be considered a last resort means of protecting the Lo Q-RPT. Following proper operating procedures, the Lo Q-RPT should never be overpressured.*

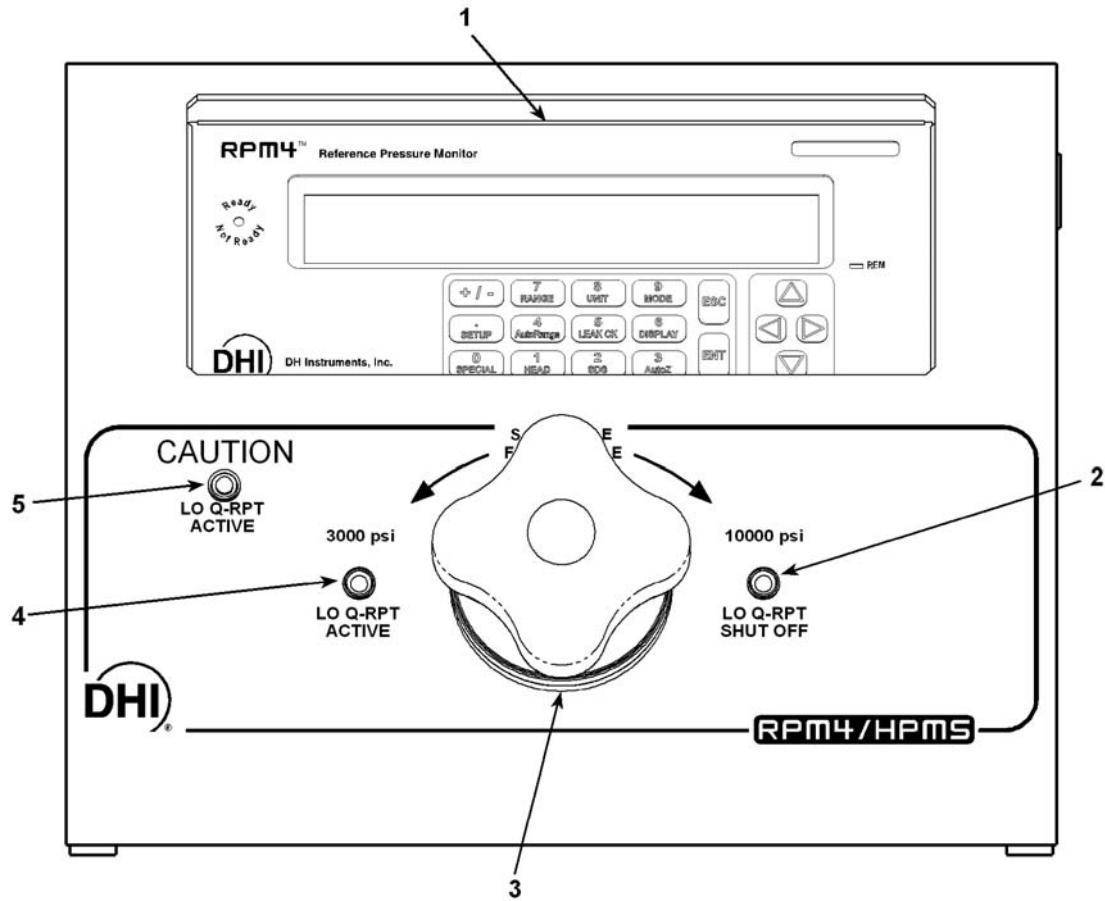

- 1. RPM4 A70M/A20M-AF Reference Pressure Monitor
- 2. Lo Q-RPT shut-off valve position LED
- 3. Lo Q-RPT shut-off valve
- 4. Lo Q-RPT active valve position LED
- 5. Lo Q-RPT active caution LED

Figure 9. RPM4/HPMS front view



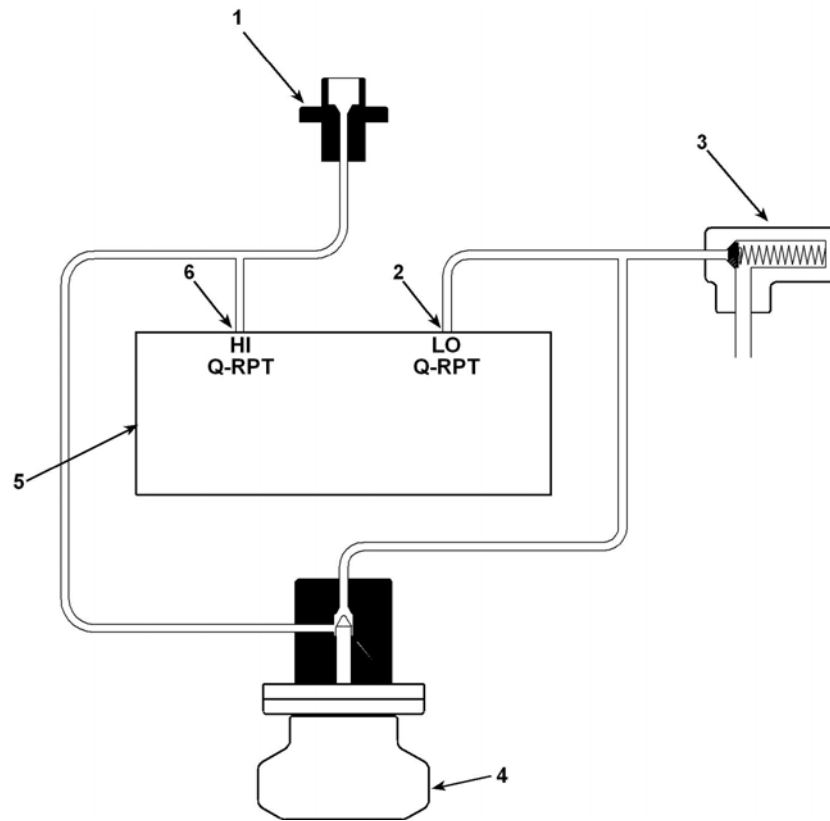

- |   |  |
|---|--|
| 1. HPMS <b>TEST</b> port (DH500 F)                | 5. RPM4 A70M/A20M-AF Reference Pressure Monitor    |
| 2. Connection to RPM4 Lo Q-RPT (A20M) (3 000 psi) | 6. Connection to RPM4 Hi Q-RPT (A70M) (10 000 psi) |
| 3. Lo Q-RPT pressure relief valve (3 300 psi)     |  |
| 4. Lo Q-RPT shut off valve                        |  |

**Figure 10.** HPMS pneumatic schematic

## 3.2.6 DIRECT FUNCTION KEYS SUMMARY



Table 3 provides a brief summary of RPM4 direct function key operation. It may be useful to keep a copy of this summary near the RPM4/HPMS, especially when first becoming acquainted with its operation.

Local operation of RPM4 is through the front panel keypad. To minimize multi-layered menu structures, the keypad numerical keys also provide direct access to the most commonly used functions. The function accessed is labeled on the bottom half of the key. Direct function keys are active whenever RPM4 is in its MAIN RUN screen. Table 3 summarizes the operation of the direct function keys.

**Table 3.** Summary of RPM4 function key operation

DIRECT FUNCTION KEYS ARE ACTIVE FROM THE MAIN RUN SCREEN			
See corresponding manual Sections for full detail.			
<b>1</b> HEAD	Adjust height of fluid head correction. Set to zero to defeat correction.	<b>7</b> RANGE	View active range and toggle through available ranges. [ENT] on a range activates it.
<b>2</b> SDS	The SDS function is not used in the A70M/A20M-AF configuration of RPM4.	<b>8</b> UNIT	Select pressure unit of measure for the active range. Choice of units available in this menu can be customized.
<b>3</b> AutoZ	Run the AutoZ function to AutoZero the active Q-RPT and measurement mode.	<b>9</b> MODE	Select the pressure measurement mode for the active range (absolute, or gauge).
<b>4</b> AutoRange	Set up and optimize RPM4 features for a specific operating range and measurement mode.	<b>0</b> SPECIAL	Menu of less commonly used internal functions and settings.
<b>5</b> LEAK CK	Run automated leak checking routine.	<b>.</b> SETUP	Menu of commonly used setup features including save/delete AutoRange ranges, set display resolution, set stability limit, set upper/lower, set up File AutoTest sequences and view AutoTest data.
<b>6</b> DISPLAY	Select the display function for the bottom line of the RPM4 display.	<b>ENT</b>	Start or set functions such as Leak Check, AutoTest and Freeze. ENTER values when editing.

## 3.3 DIRECT FUNCTION KEYS

### 3.3.1 [RANGE]

#### ○ PURPOSE

To view and/or change the active pressure measurement range and associated settings.

#### ○ PRINCIPLE

An RPM4 range is defined as a pressure span and associated settings (see Section 3.2.3).

An RPM4 may have multiple ranges. Each Q-RPT in the RPM4 system has a default range which is its maximum span. The default ranges of the RPM4 A70M/A20M are 10 000 psi (A70M) and 3 000 psi (A20M). Additional ranges, lower than the Q-RPT's maximum span, may also be created using AutoRange (see Section 3.3.4) or AutoTest (see Section 3.3.10).

Ranges created using AutoRange or AutoTest may be saved, with their settings, for reactivation (see Section 3.4.1).

The **[RANGE]** function key allows the available RPM4 pressure ranges to be viewed and selected.

### ○ OPERATION

Pressing the **[RANGE]** function key activates the range viewing and selecting function. When the **[RANGE]** function key is first pressed, the active range is displayed. For example:

1. Q-RPT designator.
2. Type of range. DF for the Q-RPT's default range; AR for a range created by AutoRange.
3. Q-RPT position designator.
4. Current pressure unit of measure.
5. Range's full scale pressure in current unit of measure in gauge and/or absolute measurement mode depending on type of Q-RPT and range.

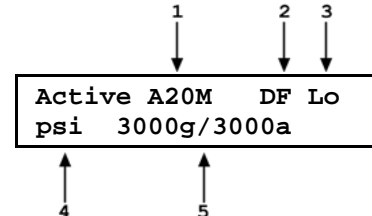

Pressing the **[+/-]** key or the **[RANGE]** key again while in the RANGE functions toggles through displays of the other available ranges, from lowest range to highest range.

To select a range to become the active range, press **[ENT]** while the range is displayed.

Any time a range change causes the active Q-RPT to change, the HPMS **Lo Q-RPT Isolation valve** must be operated to connect or disconnect the Lo RPT from the **TEST port**. The green **Lo Q-RPT Valve Position LEDs** indicate the correct position of the **Lo Q-RPT Valve Isolation Knob** based on the RPM4 Q-RPT currently in use (see Section 3.2.5).

Pressing **[ESC]** while in the RANGE function returns to the MAIN RUN screen without making a range change.

 The HPMS Lo Q-RPT Isolation valve protects the Lo Q-RPT (3 000 psi max) from overpressure when the Hi RPT is in use. Familiarize yourself with HPMS operation (see Section 3.2.5) before changing ranges and applying pressures. Always turn the Lo RPT Isolation Valve fully in the direction of the lighted green LED before applying pressure.

 Range full scale limits are given in the pressure unit that is currently active for that range.

 Pressing **[+/-]** from the MAIN RUN screen provides a shortcut to a momentary view of the active range.

 Many RPM4 settings and functions are range specific. See Table 2 for identification of range specific settings.

 For best metrological performance, vent the RPM4 Q-RPT before changing ranges.

### 3.3.2 [UNIT]

#### ○ PURPOSE

To select the unit of measure in which RPM4 displays pressure values.



To select the measurement mode (absolute, gauge), use [MODE] (see Section 3.3.3).

---

#### ○ PRINCIPLE

RPM4 allows the unit of measure in which pressure values are displayed to be changed.

RPM4 A70M/A20M-AF supports 13 standard pressure units of measure as well as user defined units. To simplify operation, quick access to six units is made available under the [UNIT] key. The [UNIT] key contents can be customized by the user to any configuration of six units (see Section 3.5.6).

---



Internally, RPM4 always operates in Pascal (Pa), the SI unit of pressure. Values of pressure are represented in other units by the application of conversion factors to convert from Pa (see Section 7.1.1).

---

#### ○ OPERATION

To change the active pressure unit of measure for a range, press [UNIT] from the MAIN RUN screen while the range is active. The display is:

1psi 2MPa 3kPa
4bar

The cursor is on the number corresponding to the active pressure unit of measure for the active range.

To change the pressure unit of measure, select the desired unit. Making the selection returns to the MAIN RUN screen with the selected unit active.

---



The pressure unit of measure selected is range specific. When in a given range, all functions and settings are represented in the current measurement unit for that range. However, certain internal and/or metrological functions (e.g., Q-RPT calibration coefficients) are always represented in Pa regardless of the current range unit.

---



See Section 7.1.1 for tables of the conversion factors used by RPM4.

---



If the pressure unit selected is inWa (inches of water), the reference temperature for water density must be specified in a separate menu (choices are 4°C, 20°C 60°F). No reference temperature selection is necessary for the unit mmWa as the only reference temperature commonly used for mmWa is 4 °C.

---



The choice of up to six units available under the UNIT function can be customized from a wider selection by the user (see Section 3.5.6). The units available under the UNIT function can be reset to default by reset (see Section 3.5.9.2).

---

### 3.3.3 [MODE]

#### ○ PURPOSE

To set the measurement mode (absolute, gauge) for the active range.



To select the unit of measure, use [UNIT] (see Section 3.3.2).

#### ○ PRINCIPLE

RPM4 A70M/A20M-AF supports simple, one-step switching between two measurement modes:

**Absolute** Measures pressure relative to vacuum (zero is hard vacuum). Range is from zero absolute to full scale.

**Gauge** Measures pressure relative to atmosphere (zero is ambient pressure). Range is from zero gauge to full scale, full scale must be greater than zero.

The RPM4 A70M/A20M-AF Q-RPTs measure pressure relative to a sealed vacuum reference and are intrinsically absolute. Gauge mode is accomplished by offsetting of atmospheric pressure with dynamic compensation for atmospheric pressure changes between offsets using an on-board barometer (see Section 3.2.2). Access to absolute operation can be turned OFF (see Section 5.3.5).

When changing modes for a range, if the full scale of the range is 100 psi (700 kPa) or greater, the full scale is the same in both absolute and gauge modes. If the full scale is less than 100 psi, the gauge mode full scale is 14.5 psi (100 kPa) lower than the absolute mode full scale.

Measurement mode selection is range specific.

#### ○ OPERATION

To change the active measurement mode for a range, press [MODE] from the MAIN RUN screen while the range is active. The display is:

Measurement mode: 1absolute 2gauge
---------------------------------------

Select the desired measurement mode and operation returns to the main run screen with the selected measurement mode active. If absolute measurement mode has been turned OFF in calibration (see Section 5.3.5), absolute mode is not available.



Certain RPM4 settings, including AutoZ ON/OFF (see Section 3.5.1) are range AND measurement mode specific. See Table 2 for a listing of settings and what they are specific to.



Absolute mode capability can be turned OFF in the calibration function (see Section 5.3.5). When absolute mode is turned OFF, only gauge mode can be activated. <Gauge mode only, other modes OFF> is displayed when [MODE] is pressed.

### 3.3.4 [AUTORANGE]

#### ○ PURPOSE

To automatically set up RPM4 to optimize its measurement characteristics and features for a specific, user defined pressure range of operation.

## ○ PRINCIPLE

RPM4 A70M/A20M-AF is designed to support the calibration and test of a very wide variety of test ranges in absolute and gauge measurement modes.

The AutoRange function simplifies the task of selecting the Q-RPT best suited to cover a specific test range and setting measurement parameters appropriately for that specific range. These are set automatically based on operator entry of desired measurement mode, pressure unit of measure and range full scale. The selections and settings made by AutoRange are summarized in Table 4.

A range set up using AutoRange and all its range specific settings, may be saved for recall using **[SETUP]**, **<1range>** (see Section 3.4.1). Saved ranges are available for later selection using **[RANGE]** (see Section 3.3.1). If a range created by AutoRange is not saved, it is overwritten by the next AutoRange or erased when another range is selected.



Press **[ENT]** from the main run screen in Rate **DISPLAY** mode to use the **[AutoTest]** function to AutoRange RPM4 based on DUT tolerance (see Section 3.3.10).

**Table 4.** Settings made by AutoRange

SETTING/ SELECTION	PURPOSE	SETTING BY [AUTORANGE]	SETTING BY [AUTOTEST] (see Section 3.3.10)	RELATED SECTION
Unit	Set pressure unit of measure	Operator specified during AutoRange	Operator specified in AutoTest definition	3.3.2
Mode	Set pressure measurement mode (absolute, gauge)	Operator specified during AutoRange	Operator specified in AutoTest definition	3.3.3
Full scale	Establish span maximum	Operator specified during AutoRange	Maximum pressure of AutoTest definition	None
Q-RPT	Select most appropriate Q-RPT to cover range and mode.	Q-RPT with lowest default full scale that is greater than the AutoRange full scale	Q-RPT with lowest default full scale that is greater than the maximum pressure of AutoTest definition	1.2.2.1
Upper limit	Set maximum pressure alarm limit.	105 % of AutoRange full scale pressure	105% of maximum pressure of AutoTest definition	3.4.4
Resolution	Set display resolution	10 ppm of AutoRange span or 1 ppm of default Q-RPT span, whichever is larger	10% of DUT tolerance or 1 ppm of default Q-RPT span, whichever is larger.	3.4.2
Stability Limit	Set <i>Ready/Not Ready</i> stability criterion.	50 ppm of AutoRange span or 2 ppm of default Q-RPT span, whichever is larger	10% of DUT tolerance or 2 ppm of default Q-RPT span, whichever is larger	3.4.3, 3.2.1

## ○ OPERATION

To use the AutoRange function, press **[AutoRange]** and respond to the RPM4's prompts.

- ❶ **Select AutoRange measurement mode:** The screen is identical in appearance and function to the **[MODE]** screen (see Section 3.3.3).
- ❷ **Select pressure unit of measure:** The screen is identical in appearance and function to the **[UNIT]** screen (see Section 3.3.2).
- ❸ **Enter the AutoRange full scale pressure:** Enter the full scale pressure value in the **<----->** entry field and press **[ENT]**. If the full scale value entered cannot be covered by RPM4, an error message appears. If the full scale value can be covered, AutoRange proceeds to the range display.
- ❹ **View proposed AutoRange range:** The proposed AutoRange range screen is:

1. Indication that this is a screen of the proposed AutoRange range.
2. Designator and position of the Q-RPT that AutoRange has selected to cover the AutoRange full scale and measurement mode.
3. Pressure unit of measure specified in AutoRange.
4. AutoRange full scale pressure in gauge mode and absolute.

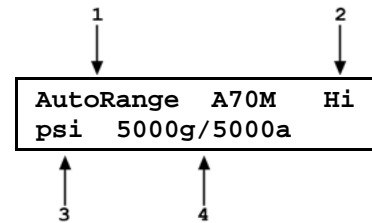

 If AutoRange selects a Q-RPT but you would like to use the other one, the **[◀]** and **[▶]** cursor control keys may be used to toggle between Q-RPTs so that the other can be selected.

- ❺ **Accept proposed AutoRange:** To accept the proposed AutoRange and go to the MAIN RUN screen with the new AutoRange range active, press **[ENT]** or **[AutoRange]**. To modify the AutoRange full scale, measurement mode or pressure unit of measure, use **[ESC]** to back through the AutoRange screens and make changes.

 The HPMS Lo Q-RPT Isolation Valve protects the Lo Q-RPT (3 000 psi max) from overpressure when the Hi Q-RPT is in use. Familiarize yourself with HPMS operation (see Section 3.2.5) before changing ranges and applying pressures. Always turn the Lo Q-RPT Isolation Valve fully in the direction of the lighted green LED before applying pressure.

 To verify or confirm the range from the MAIN RUN screen, use **[+/-]** or **[RANGE]** to view the active range (see Section 3.3.1).

 See Table 4 for a listing of all selections and settings affected by AutoRange and their values.

### 3.3.5 [LEAK CK]

#### ○ PURPOSE

To run an automated leak check routine that determines the leak rate of the system connected to the RPM4/HPMS **TEST** port.

#### ○ PRINCIPLE

The LEAK CHECK function is provided as a means of checking and quantifying the leaks that may be present in the system connected to the RPM4/HPMS **TEST** port.

The principle of the LEAK CHECK function is the measurement of the natural decrease or increase of pressure in a fixed volume over time. The LEAK CHECK function allows a leak check time to be set. The total pressure change and the average rate of change over the leak check time are calculated and displayed.

**○ OPERATION**

To run a leak check, first set the pressure to the desired leak check pressure.

 *Changing the pressure in a test system causes adiabatic temperature changes in the pressurized medium that need to have dissipated before a valid leak measurement can be made. In general, a 0.5 to 1 minute wait before running a leak check is adequate to allow the adiabatic temperature change to dissipate and valid leak measurements to be made. However, stabilization time may be much longer for large pressure changes and as volume and pressure increases.*

To access the LEAK CHECK function, press **[LEAK CHECK]** from the MAIN RUN screen. Select **<1run>** to run a leak test. The display is:

1. Edit field for the time over which the leak rate will be determined, in seconds.

```
Set leak check time:
15 s
```



Edit the leak check time if desired (minimum 1, maximum 999 seconds) and press **[ENT]**. Press **[ENT]** again when ready to start the leak test. The leak test display is:

1. Standard MAIN RUN screen first line showing measured pressure.
2. Active Q-RPT position indicator
3. Indication that leak test is running and countdown of time remaining.

```
4566.8 psi g      Hi
Leak testing      13 s
```



**[ESC]** can be used to abort the running leak test. **[ENT]** while the leak test is running restarts the leak check timer. When the leak check timer countdown has completed, RPM4 beeps three times and the leak check results screen is displayed:

1. Total pressure change from start to finish of leak check time.
2. Indicator of Q-RPT used to run the leak check.
3. Average rate of change of pressure over the leak check time period ( $\Delta P$ /time in seconds).

```
ΔP - 0.12 psi g Hi
Rate 0.008 psi/sec
```



From the leak check results screen, press **[ENT]** to repeat the leak test.

Press **[ESC]** to return to leak check main menu and exit to the MAIN RUN screen.

To view the results of the most recently completed leak check, press **<2view>**. If NO leak check data is stored (i.e., if the RPM4 has never run a leak test or a reset has cleared previous leak test results), the results screen displays **<Data NOT available>** briefly and returns to MAIN RUN screen. Press **[ENT]** or **[ESC]** to return to the MAIN RUN screen.





Leak check is range specific in the sense that a leak check is run using the active range. However, only one set of leak check results is maintained in memory and each leak test completed overwrites the memory. View leak check always shows the results of the last leak check run regardless of the range that is now active. The results screen includes the range indicator to indicate the range in which the leak check was run.

### 3.3.6 [DISPLAY]

#### ○ PURPOSE

To select, from a variety of choices, the information that is displayed on the second line of the RPM4 display.

#### ○ PRINCIPLE

RPM4 supports a variety of advanced pressure measurement functions that are displayed on the second (bottom) line of the RPM4 display. In summary, the available display functions included are:

- AVERAGE** Calculates the average measured pressure over a user specified period of time and displays the average, the standard deviation about the mean and a countdown in seconds to the next average (see Section 3.3.6.1). This function is often used to filter out pressure noise in an unstable system. The magnitude of the noise is quantified by the standard deviation about the mean. A second Avg screen allows the instantaneous pressure values to be viewed during an averaging cycle.
- RATE** Calculates and displays the current rate of change of pressure in current pressure units/second (see Section 3.3.6.2). This function is a useful indication of the stability of the pressure being measured. It is often used as an indication of positive or negative leak rate and as a go/no go criterion of when to take data when comparing RPM4 and a device under test, for example in a calibration. Rate is used by the Ready/Not Ready function to determine when a Ready condition exists (see Section 3.2.1).
- DEVIATION** Continuously calculates and displays the difference between the pressure measured by RPM4 and a target pressure entered by the user (see Section 3.3.6.3). This function is useful in monitoring the evolution of pressure around and/or away from a desired set point.
- RPT** Allows pressure measurement from the RPM4's two Q-RPTs to be displayed simultaneously (see Section 3.3.6.4).
- HI/LO** Records and displays maximum and minimum pressures measured (see Section 3.3.6.5). This function is used to keep track of the minimum and maximum pressure observed in a system over a period of time or to monitor if a pressure min/max limit has been exceeded..
- FREEZE** Captures and displays the pressure measured by the active range of RPM4 when the **[ENT]** key is pressed (see Section 3.3.6.6). This function is useful to record the pressure present at the time of an operator observed trigger event, for example when the needle of an analog gauge is on the nominal point or when a switch activates.
- CLEAN** Blanks out the second line of the display (see Section 3.3.6.7). This function is used when a simple display of pressure measured by the RPM4 active range with minimal additional information is desired.

○ OPERATION

To set the DISPLAY function press **[DISPLAY]** from the main run screen.

The display is:

```
1avg 2rate 3dev 4RPT
5HiLo 6freeze 7clean
```

The cursor is on the active DISPLAY function. Selecting a DISPLAY function returns to the main run screen with the selected function active. See Sections 3.3.6.1 to 3.3.6.7 for information on each of the DISPLAY choices.



The DISPLAY selection is NOT range specific. A DISPLAY selection made in one range applies to all ranges.



The default DISPLAY function is Rate which causes the second line of the display to show "R" followed by the current rate of change of pressure in current pressure units per second.

### 3.3.6.1 AVG (AVERAGE)

○ PURPOSE

To activate the Average DISPLAY and/or adjust the period of time over which averaging occurs.



See Section 3.3.6. ○ Principle.

○ OPERATION

To access the Average DISPLAY, press **[DISPLAY]**, **<1Avg>**. The display is:

1. Edit field for averaging period in seconds. Default is 20. Minimum 1, maximum 999.

```
Averaging Period:
                20 s
```

↑  
1

Edit the averaging time period if desired. Press **[ENT]** to return to the main run screen with the Average DISPLAY active.

With the Average DISPLAY active the main run screen is:

1. Average measured pressure over last completed averaging period.
2. Standard deviation in active pressure unit of measure of last completed averaging period.
3. Countdown in seconds until completion of on-going averaging period.

```

1 ↓
3001.57 psi a Hi
δ 0.03          18Avg
    ↑           ↑
    2           3
```

The Average DISPLAY has a second screen that allows the instantaneous pressure readings to be viewed while an averaging cycle is running. The instantaneous Average screen is:

1. Instantaneous pressure values at RPM4's normal update rate.
2. Current rate of change of pressure in active pressure unit/second.
3. Countdown in seconds until completion of on-going averaging period.

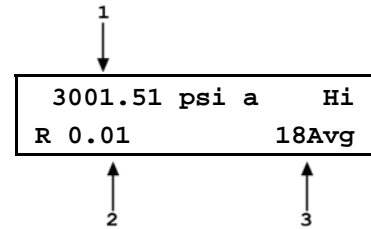

The **[+/-]** key toggles between the main run Average screen and the instantaneous values Average screen.



Pressing **[ENT]** while in the Average DISPLAY aborts the current averaging period and causes a new one to begin. **[ENT]** can thus be used to trigger a new averaging period on demand.



In the Average DISPLAY the Ready/Not Ready indication applies to the result of the previous averaging period (see Section 3.2.1). Ready indicates that all readings during the previous averaging period met the stability criterion. Not Ready indicates that one or more readings were outside of the stability criterion.



Changing the pressure unit of measure, measurement mode or range while the averaging screen is active, starts a new averaging period.



To go to a DISPLAY other than Average, press **[DISPLAY]** and make a new DISPLAY choice (see Section 3.3.6).

### 3.3.6.2 Rate

#### ○ PURPOSE

To activate the Rate DISPLAY.



See Section 3.3.6, ○ Principle.



The AutoTest function (see Section 3.3.10) to AutoRange RPM4 based on DUT characteristics and run an automated test sequence is accessed by pressing **[ENT]** from the Rate run screen.

**○ OPERATION**

To activate the Rate DISPLAY press **[DISPLAY]**, **<2Rate>**. Pressing **<2Rate>** returns to the main run screen with the Rate DISPLAY active.

With the Rate DISPLAY active the main run screen is:

1. Current rate of change of pressure in current pressure unit per second.

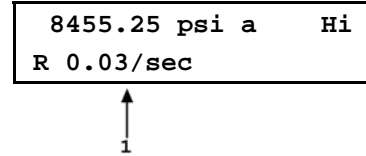

The Rate DISPLAY is different and separate from the stability setting which is used to set the stability criterion on which the Ready/Not Ready indication is based (see Sections 3.4.3 and 3.2.1). The Rate DISPLAY only causes the current rate of change to be displayed and has NO effect on the stability setting or the Ready/Not Ready condition.



The Rate DISPLAY is the default RPM4 main run screen display.



To go to a DISPLAY other than Rate, press **[DISPLAY]** and make a new DISPLAY choice (see Section 3.3.6).

**3.3.6.3 Dev (Deviation)**

**○ PURPOSE**

To activate the Deviation DISPLAY and/or set the deviation target value.



See Section 3.3.6, ○ Principle.

**○ OPERATION**

To activate the Deviation DISPLAY press **[DISPLAY]**, **<3Dev>**. The display is:

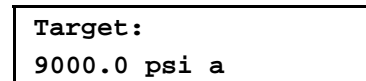

Edit the desired target value. Pressing **[ENT]** returns to the main run screen with the Deviation DISPLAY active using the entered target value.



The target value is the value from which deviations (D) are measured by the Deviation DISPLAY following:

$$D = \text{current pressure} - \text{target pressure}$$

With the Deviation DISPLAY active the main run screen is:

1. Deviation of current pressure from the target value.
2. Target value.

8998.2	psi	a	zH3
D -1.8	T9000.0		
↑	↑		
1	2		



Pressing [ENT] from the main run screen when the Deviation DISPLAY is active goes directly to the Target editing screen. This allows the target value to be changed and without going through the DISPLAY menu.



If the pressure measurement unit or mode is changed while the Deviation DISPLAY is active the target value remains at the same numerical value. It is NOT converted.



To go to a DISPLAY other than Deviation, press [DISPLAY] and make a new DISPLAY choice (see Section 3.3.6).

#### 3.3.6.4 RPT

##### ○ PURPOSE

To activate the RPT DISPLAY.



See Section 3.3.6, ○ Principle.

##### ○ OPERATION



For the sake of clarity, when describing the RPT DISPLAY, the Q-RPT displayed on the top line of the display when the RPT function is selected is referred to as the “active” Q-RPT. The other Q-RPT to be displayed on the second (bottom) line of the RPM4 display is referred to as the “inactive” Q-RPT. It is “inactive” in the sense that all RPM4 functions and settings such as UNIT and RES still apply to the “active” Q-RPT. To make changes to the “inactive” Q-RPT, for example to change its pressure measurement unit, it must be made the active Q-RPT by a conventional range change (see Section 3.3.1).

To activate the RPT DISPLAY, press [DISPLAY], <4RPT>. Operation returns to the MAIN RUN screen with the inactive Q-RPT displayed on the display’s bottom line. The range of the inactive Q-RPT is always the default range, not an AutoRanged range (see Section 3.2.3).

With the RPT DISPLAY active the main run screen is:

1. Active Q-RPT display.
2. Inactive Q-RPT display with *Ready/Not Ready* indicator on far left (<\*> indicates *Ready*).

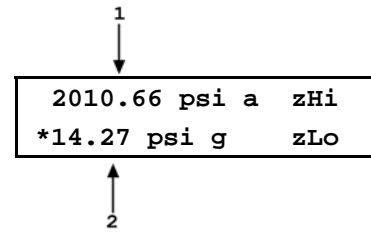

When the RPT display is active, executing a range change to a range on the inactive Q-RPT makes the inactive Q-RPT the active Q-RPT. The DISPLAY defaults back to Rate (Section 3.3.6.2).



To go to a DISPLAY other than RPT, press [DISPLAY] and make a new DISPLAY choice (see Section 3.3.6).

### 3.3.6.5 Hi/Lo

#### ○ PURPOSE

To activate the Hi/Lo DISPLAY.



See Section 3.3.6, ○ Principle..

#### ○ OPERATION

To activate the Hi/Lo DISPLAY press [DISPLAY], <5Hi/Lo>. Pressing <5Hi/Lo> resets the Hi/Lo values and returns to the main run screen with the Hi/Lo DISPLAY active.

With the Hi/Lo DISPLAY active the main run screen is:

1. Highest pressure observed since Hi/Lo reset.
2. Lowest pressure observed since Hi/Lo reset.

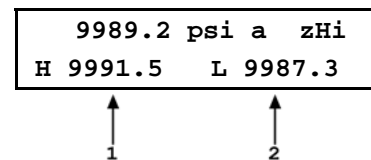

The Hi/Lo values change each time a new Hi or Lo pressure is observed.



The Hi/Lo record can be reset at any time by pressing [ENT]. This allows a Hi/Lo reset without going back through the DISPLAY menu.



If the pressure measurement unit, mode or range is changed while the Hi/Lo DISPLAY is active, Hi/Lo resets.



To go to a DISPLAY other than Hi/Lo, press [DISPLAY] and make a new DISPLAY choice (see Section 3.3.6).

## 3.3.6.6 Freeze

## ○ PURPOSE

To activate the Freeze DISPLAY.



See Section 3.3.6, ○ Principle.

## ○ OPERATION

To activate the Freeze DISPLAY press **[DISPLAY]**, **<6Freeze>**. Pressing **<6Freeze>** returns to the main run screen with the Freeze DISPLAY active.

With the Freeze DISPLAY active the main run screen is:

1. Pressure measured by active range of RPM4 when **[ENT]** was pressed (displays 0.00 by default when Freeze DISPLAY is first activated).

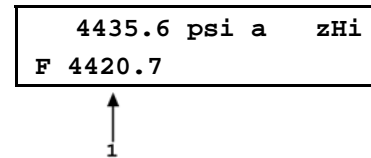

Pressing **[ENT]** causes the current pressure measured by the active RPM4 Q-RPT to be captured and displayed.



If the pressure measurement unit, mode or range is changed while the Freeze DISPLAY is active, the Freeze value defaults back to zero.



To go to a DISPLAY other than Freeze, press **[DISPLAY]** and make a new DISPLAY choice (see Section 3.3.6).

## 3.3.6.7 Clean

## ○ PURPOSE

To activate the Clean DISPLAY.



See Section 3.3.6, ○ Principle..

## ○ OPERATION

To activate the Clean DISPLAY press **[DISPLAY]**, **<7Clean>**. Pressing **<7Clean>** returns to the main run screen with the Clean DISPLAY active.

With the Clean DISPLAY active the main run screen is:

1. Conventional main run screen first line.
2. "Clean" second line.

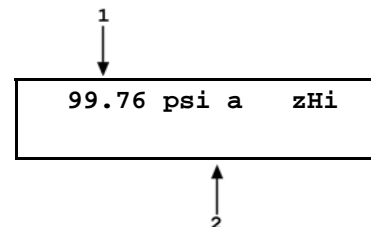

To go to a DISPLAY other than Clean, press **[DISPLAY]** and make a new DISPLAY choice (see Section 3.3.6).

### 3.3.7 [HEAD]

#### ○ PURPOSE

To cause a pressure fluid head correction to be added to or subtracted from the pressure measured by the RPM4 reference pressure transducer in order to predict the pressure at a height other than the RPM4/HPMS's reference level.

#### ○ PRINCIPLE

RPM4/HPMS measures gauge or absolute pressure at the height of the rear panel **TEST** port. Frequently, when performing a calibration or test, the device or system under test is at a different height than the RPM4/HPMS's **TEST** port. This difference in height, frequently called **head**, can cause a significant difference between the pressure measured by the RPM4/HPMS at its **TEST** port height and the pressure actually applied to the device under test which is at a different height. In this case, it is useful to make a head correction to the pressure measured by the RPM4 in order to predict the pressure actually applied at a different height.

RPM4 can accurately determine "head" pressures for gases (nitrogen, helium and air) and liquids (oil, water) as the pressurized medium. In calculating the head value, standard gravity ( $9.80665 \text{ m/s}^2$ ) is used. Gas densities are calculated from the selected gas's standard density correcting for temperature of  $20^\circ\text{C}$  and the measured pressure using the gas's compressibility factor to 100 MPa (15 000 psi) and extrapolated above 100 MPa. Oil density is taken to be  $850 \text{ kg/m}^3$ , the density of typical calibration oils at  $20^\circ\text{C}$ . Water density is taken to be  $998.2321 \text{ kg/m}^3$  ( $20^\circ\text{C}$ ). A custom liquid density may also be specified.

The **[HEAD]** function key is used to specify the height difference between the RPM4/HPMS **TEST** port and another height. Entering a height of zero turns the function off. The height units and the test medium can be changed using **[SPECIAL]**, **<3Head>** (see Section 3.5.3).



*As a general rule with RPM4 A20M/A70M-AF, use of the HEAD function to assure in tolerance measurements with RPM4 A70M/A20M-AF is necessary only when the head exceeds 10 in. (25 cm) if the medium is a gas.*

#### ○ OPERATION

To access the HEAD function, press **[HEAD]**. The display is:

1. Edit field for head height.
2. Test gas currently specified for the head correction.

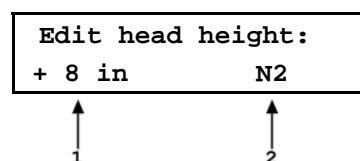

Edit the head height to the desired value. Press **[ENT]** to return to the MAIN RUN screen with the new head correction active. Press **[ESC]** to return with no changes.



*The reference height of the RPM4 pressure measurement is the middle of the RPM4 TEST port. The head height should be entered as a positive value if the device or system under test is higher than the RPM4 and negative if it is lower.*

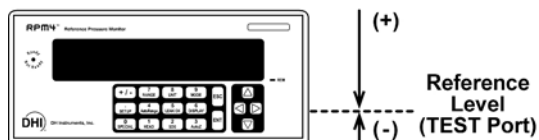

*The HEAD function is NOT range specific. The HEAD ON or OFF status remains the same as Q-RPTs and ranges are changed. Edits made to the head settings are independent of active range or Q-RPT.*





When a head correction is being applied, it is indicated by <h> in the fourth character from the right in the top line of the MAIN RUN screen (see Section 3.1.1). When the head correction is zero, the <h> is not shown.



The default head height unit is inches and the fluid species is Nitrogen (N<sub>2</sub>). To change units of head height between inches and centimeters and to change the test fluid species, use [SPECIAL], <3head> (see Section 3.5.3).

### 3.3.8 [SDS]

#### ○ PURPOSE

The SDS function is not used in RPM4 A70M/A20M-AF.

### 3.3.9 [AUTOZ]

#### ○ PURPOSE

To run the AutoZ function that rezeros the active Q-RPT between full calibrations.



See Section 3.5.1, ○ Principle for a full explanation of the AutoZ function.

#### ○ PRINCIPLE

Run AutoZ is the function by which the current Q-RPT reading is compared to a reference,  $P_{std,0}$ , at atmospheric pressure to determine a new value of  $P_{offset}$ . The value of  $P_{offset}$  is then used by AutoZ to automatically correct the Q-RPT for possible changes in zero over time (see Section 3.5.1, ○ PRINCIPLE).

#### 3.3.9.1 [AUTOZ] IN GAUGE MODE

##### ○ PURPOSE

To “rezero” the active Q-RPT in gauge measurement mode.



See Section 3.5.1, ○ Principle for a full explanation of the AutoZ function.

##### ○ OPERATION



For the AutoZ function key to run AutoZ, AutoZ must be turned ON for the active range and measurement mode. AutoZ ON is indicated by <z> to the left of the Q-RPT designator on the first line of the main run screen. AutoZ ON and OFF is set using [SPECIAL], <1AutoZ> (see Section 3.5.1). If AutoZ is OFF for the active Q-RPT, and measurement mode, <AutoZ is off> is displayed when [AutoZ] is pressed.

To run AutoZ in gauge measurement mode, use [MODE] to set gauge as the measurement mode (see Section 3.3.3) and press [AutoZ] from the main run screen. <Running gauge AutoZ> is displayed briefly before returning to the main run screen.



Before running AutoZ in gauge mode, ensure that the pressure applied to the Q-RPT is truly zero gauge (atmospheric pressure). If running AutoZ in gauge mode results in a zero offset that RPM4 considers unusually large, <Confirm 0 gauge P!> is displayed. Check that zero gauge pressure is applied to the Q-RPT module rear panel TEST(+) port and the ATM port is open to atmosphere and unobstructed.



Allow the RPM4 to stabilize at atmospheric pressure and ambient temperature for 2 to 3 minutes before running AutoZ in gauge mode.

### 3.3.9.2 [AUTOZ] IN ABSOLUTE MODE

#### ○ PURPOSE

To “rezero” the active Q-RPT in absolute measurement mode



See Section 3.5.1, ○ Principle for a full explanation of the AutoZ function.

#### ○ OPERATION



For the AutoZ function key to run AutoZ, AutoZ must be turned ON for the active Q-RPT and measurement mode. AutoZ ON is indicated by <z> to the left of the range designator on the first line of the main run screen. AutoZ ON and OFF is set using [SPECIAL], <1AutoZ> (see Section 3.5.1). If AutoZ is OFF for the active range, and measurement mode, <AutoZ OFF> is displayed when [AutoZ] is pressed.

To run AutoZ in absolute measurement mode, use [MODE] to set absolute measurement mode (see Section 3.3.3) and press [AutoZ] from the main run screen. The display is:

1. Active Q-RPT designator.
2. Current measurement mode (absolute).
3. Selection of source of  $P_{std,0}$  reference to which to AutoZ.

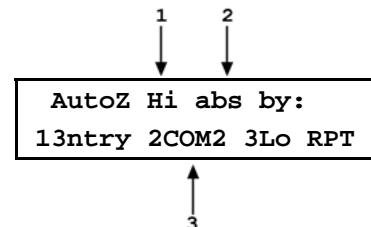

Selecting <1ntry> allows the value of  $P_{std,0}$  to be entered from the front panel keypad.

Selecting <2COM2> allows the value of  $P_{std,0}$  to be read automatically from another DHI RPMx connected to RPM4's COM2 communications port.

Selecting <3Lo RPT > is shown only if the Hi Q-RPT is active. This selection allows the value of  $P_{std,0}$  for the Hi Q-RPT to be read automatically from the RPM4s Lo Q-RPT.



Allow the RPM4 to stabilize at atmospheric pressure and ambient temperature for 5 to 10 minutes before running AutoZ in absolute mode.



If running AutoZ results in a value of  $P_{\text{offset}}$  that is greater than  $\pm 0.005\%$  FS of the span of the Q-RPT that is being AutoZeroed, the Q-RPT and/or the reference used as the source of  $P_{\text{std},0}$  may be out of tolerance or the AutoZ process may have been faulty. Before activating a new  $P_{\text{offset}}$  greater than  $\pm 0.005\%$  FS of the active Q-RPT, check to be sure that both the Q-RPT and the reference were in good working order, properly vented to stable atmospheric pressure, at the same height, and reading in the same pressure units when AutoZ was run.



When the run AutoZ selection is made, if a HEAD correction is currently active (see Section 3.3.7) the head correction is momentarily disabled while running AutoZ to avoid “zeroing out” the head value.



The value of  $P_{\text{offset}}$  is always displayed and entered in Pascal (Pa).

### Run AutoZ by Entry



Before running AutoZ in absolute mode, use <SETUP>, <2res> to set the resolution of the active range to 0.001 or 0.0001%FS.

AutoZ by entry allows the value of  $P_{\text{std},0}$  (see Section 3.5.1, ○ PRINCIPLE) to be entered manually from the RPM4 front panel. This provides a simple way of AutoZeroing relative to an independent reference device such as a house barometer that does not interfaced directly with RPM4.

To run AutoZ by entry press [AutoZ], <1entry>. The display is:

1. Real time pressure reading (without head correction), pressure unit of measure and measurement mode of the active Q-RPT.
2. Active Q-RPT position designator.
3. Entry field for the value of  $P_{\text{std},0}$  in the current pressure unit of measure.

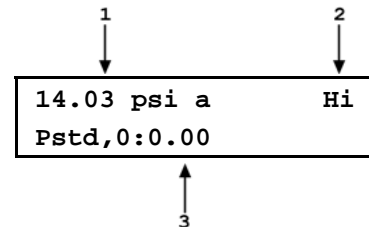

Enter the value of the AutoZ reference ( $P_{\text{std},0}$ ) in the same unit of measure as the top line display and press [ENT]. RPM4 logs the reading and calculates a new AutoZ offset value. The next display is:

Press [ENT] to activate the new value of  $P_{\text{offset}}$  or [ESC] to start over with entry of a new AutoZ reference ( $P_{\text{std},0}$ ) value.

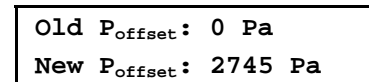

The value of  $P_{\text{offset}}$  is always in Pascal (Pa). The value of  $P_{\text{std},0}$  is entered in the current pressure unit of measure.

### Run AutoZ by COM2

AutoZ by COM2 allows the value of  $P_{std,0}$  (see Section 3.5.1 ○ Principle) to be read automatically from a **DHI** RPMx connected to the RPM4 COM2 communications port. The RPMx is read and the new  $P_{offset}$  is calculated automatically.

To access run AutoZ by COM2 press **[AutoZ]**, **<2COM2>**. The display is:

1. Real time pressure reading (without head correction), pressure unit of measure and measurement mode of the active Q-RPT.
2. Active Q-RPT position designator.
3. Real time reading from the RPMx connected to RPM4's COM2 communications port.

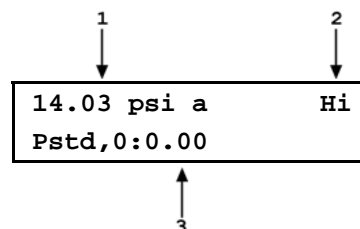

Observe the displayed pressures and verify that they are stable. When ready, press **[ENT]** to cause AutoZ to run. RPM4 logs both readings and calculates a new AutoZ offset value. The display is:

Press **[ENT]** to activate the new value of  $P_{offset}$  or **[ESC]** to start over.

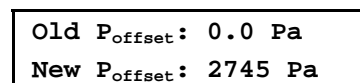

 For RPM4 to communicate with an RPMx connected to its COM2 port, the RPM4 and the RPMx RS-232 interfaces must be set up properly (see Section 3.5.2). If the RPM4 is unable to communicate with an RPMx via COM2 when running AutoZ by COM2, it times out after 6 seconds and displays <RPM NOT detected>.

 The value of  $P_{offset}$  is always displayed and entered in Pascal (Pa).

### Run AutoZ by Lo RPT

AutoZ by Lo RPT is available only when the active Q-RPT is the Hi Q-RPT. AutoZ by Lo RPT allows the Lo Q-RPT in an the RPM4 to serve as the AutoZ reference (source of  $P_{std,0}$ ) (see Section 3.5.1, ○ PRINCIPLE). The Lo Q-RPT is read and the new  $P_{offset}$  is calculated automatically.

To access run AutoZ by Lo Q-RPT press **[AutoZ]**, **<3Lo RPT >**. The display is:

1. Real time pressure reading (without head correction), pressure unit of measure and measurement mode of the active Q-RPT.
2. Active Q-RPT position designator.
3. Real time reading from the Lo Q-RPT.

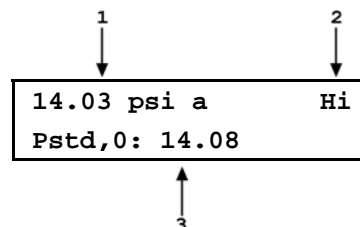

Observe the displayed pressures and verify that they are stable. When ready, press **[ENT]** to cause AutoZ to run. RPM4 logs both readings and calculates a new AutoZ offset value. The display is:

Press **[ENT]** to activate the new value of  $P_{offset}$  or **[ESC]** to start over.

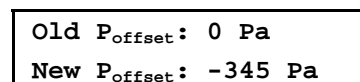

 The value of  $P_{offset}$  is always displayed and entered in Pascal (Pa).

### 3.3.10 [ENT] (RUN AUTOTEST)

#### ○ PURPOSE

To run the AutoTest function which runs a calibration test sequence (Quick Test or File Test).



Run AutoTest is accessed by pressing [ENT] from the Rate or Clean DISPLAY mode (see Section 3.3.6). In other DISPLAY modes, the function of [ENT] is specific to the mode.

#### ○ PRINCIPLE

RPM4 supports AutoTest automated sequences to assist in the testing or calibration of analog gauges and other pressure sensitive devices.

The AutoTest function is intended to:

- AutoRange the RPM4 (see Section 3.3.4) to the range of the DUT being tested with settings appropriate for the tolerance of the DUT.
- Step the operator through a planned sequence of test pressure increments if desired.
- Alert the operator to possible out of tolerance conditions at each test point.
- Log test data in RPM4 that can be viewed following the test.

There are two types of AutoTest: Quick AutoTest and File AutoTest.

- Quick AutoTest: The DUT and test parameters are entered “on the fly” during the initialization of the test, then the test is executed if desired. In Quick AutoTest tests, the test points are defined in % of test FS pressure.
- File AutoTest: The DUT and test parameters are stored in a file (see Section 3.4.5.2) and retrieved when a DUT is to be tested. In File AutoTests, test points are defined individually.

AutoTest operation is oriented towards running tests in which the pressure is set to the DUT cardinal point indication and then the actual reference pressure present is read from the RPM4.

#### **AutoTest Settings and Calculations**

The data required to initialize an AutoTest is either entered “on the fly” (Quick AutoTest) or retrieved from a file (File AutoTest). The data items required are:

- Pressure measurement mode (gauge or absolute).
- Pressure unit of measure.
- DUT full scale in pressure unit of measure.
- DUT tolerance in  $\pm$  % FS (full scale).
- Test increment in % FS (Quick AutoTest) or number of test increments and the value of each increment in the pressure unit of measure (File AutoTest).
- Test point sequence: ascending, descending or both (Quick AutoTest only).

The initialization data is used to AutoRange the RPM4 appropriately for the DUT and test to be run. At the end of the AutoTest initialization, the RPM4 is AutoRanged as follows (see Section 3.3.4, Table 4):

- Q-RPT: The Lo Q-RPT is active if the maximum pressure in the AutoTest is less than 20 MPa (3 000 psi), the Hi Q-RPT is active if the maximum pressure in the AutoTest is greater than 20 MPa (3 000 psi).
- Pressure measurement mode and unit: As specified in the AutoTest initialization.
- Display resolution: The DUT tolerance divided by 10 and rounded to the nearest digit, or 1 ppm of Q-RPT span, whichever is greater.

- Stability test for *Ready/Not Ready* indication(see Section 3.2.1): The DUT tolerance divided by 10, or 2 ppm of Q-RPT span, whichever is greater.
- Upper limit (UL): The DUT full scale plus 5 %, or the Q-RPT's maximum UL, whichever is less (see Section 3.4.4).

To AutoRange the RPM4 based on DUT characteristics but not execute an AutoTest, the AutoTest can be aborted just after the initialization. Then the RPM4 is set up appropriately for the DUT to be tested but the AutoTest increments don't execute.

See **OPERATION** in this Section for information on running a Quick or File AutoTest.

See Section 3.4.5.2 for information on setting up File AutoTest files.

See Section 3.4.5.1 for information on viewing the data files that result from running a File AutoTest.

### ○ OPERATION

To run an AutoTest, press **[ENT]** from the Rate, RPT or Clean run screen (DISPLAY modes that do not use **[ENT]** (see Section 3.3.6)). The display is:

```
Run AutoTest:
1Quick 2File
```

Select **<1Quick>** to run a Quick AutoTest or **<2File>** to run a File AutoTest (see **PRINCIPLE** above in this Section).

If **<2File>** is selected, the File AutoTest file number must be specified (see Section 3.4.5.2). The test is initialized automatically using the information in the File AutoTest file and test execution begins with the **<SET VALVE FOR RPT>** screen (see Section 3.2.10.2).

If **<1Quick>** is selected, test initialization begins with the **<Measurement mode:>** screen (see Section 3.2.10.1)

### 3.3.10.1 AUTOTEST INITIALIZATION

When **<2File>** is selected to run a File AutoTest, the test initialization information is obtained from the file selected. Operation proceeds directly to the test confirmation. The RPM4 asks the operator to confirm the range of the AutoTest (**<ENTER to run...>**), AutoRanges (see Section 3.3.4) and operation proceeds directly to test execution (see Section 3.3.10.2).

When **<1Quick>** is selected to run a Quick AutoTest, the display is:

```
Run current Quick
AutoTest: 1yes 2no
```

This selection provides the choice between running the last Quick AutoTest, including AutoRanging the RPM4 based on the previously entered DUT characteristics or setting up a new Quick AutoTest definition. Select **<1yes>** to rerun the last Quick AutoTest (see below in this Section). Select **<2no>** to define a new Quick AutoTest.

When **<2no>** is selected from the **<Run current Quick AutoTest>** screen, the AutoTest set-up/edit routine is accessed. The information needed to AutoRange RPM4 based on the DUT characteristics is then collected in successive screens as follows.

- **<Measurement mode:>**: Select **<1gauge>** or **<2absolute>** depending on the measurement mode of the DUT being tested (see Section 3.3.3).
- **<Pressure units of measure>**: The units of measure screen from the **[UNIT]** function key is presented (see Section 3.3.2). Select the desired pressure unit of measure. The choice of units may be modified (see Section 3.5.6).
- **<DUT full scale:>**: Enter the full scale pressure (maximum pressure) of the DUT in the measurement mode and pressure units that have been specified in the previous two steps.

- **<DUT tolerance>:** Enter the DUT measurement uncertainty, accuracy or precision specification as desired in  $\pm$  % FS (percent of full scale). This value will be used to determine appropriate RPM4 resolution and stability test settings.
- **<Test increment>:** Enter the test increment in % FS of the DUT. When executing the test, the test increments will be from zero to the DUT full scale, dividing by the value of the increment. If a non-even increment value is entered, the actual increments will be rounded to the lower number of increments. For example, if the DUT full scale is 10 000 psi and the increment specified is 42 %, the Sequence will run points of 0, 5 000 and 10 000 psi because 42 % goes into 100 less than three but more than two times.
- **<Test point sequence>:** Select **<1up>** for the AutoTest sequence to run from zero to the DUT full scale; **<2down>** for the sequence to start at the DUT full scale and run down to zero, **<3u&d>** for the sequence to run from zero to the DUT full scale and back to zero; **<4d&u>** for the sequence to run from the DUT full scale down to zero and back to the DUT full scale.

After the last test definition entry, a screen is offered for the user to check that the correct test has been defined or selected and that it does not exceed the range of the device or system being tested. :

1. Indication of minimum and maximum pressure included in the sequence which is about to run.

ENTER to run psi g  
 0.000 to 5000.0



Pressing **[ESC]** returns to the AutoTest selection screen without AutoRanging the RPM4 and without sequence execution. Pressing **[ENT]** causes the RPM4 to AutoRange based upon the DUT characteristics (see Section 3.3.4) and the AutoTest proceeds to text execution (see Section 3.3.10.2). To AutoRange the RPM4 based on DUT characteristics but not run a test sequence, **[ESC]** right after AutoRanging completes (at the **<Set valve for ...>** screen).

### 3.3.10.2 TEST EXECUTION

The last step of test initialization is to AutoRange the RPM4 (see Section 3.3.10.1), then test execution begins.

The first step of test execution is to set the HPMS Lo Q-RPT isolation valve correctly for the Q-RPT that will be used to run the test (see 3.2.5). The RPM4 display is (**<XX>** is Lo or Hi):

Set valve for XX RPT  
 Set supply to DUT FS

Set the HPMS isolation valve to shut off or use the RPM4's Lo Q-RPT as indicated by the HPMS valve indicator LED (see Section 3.2.5). Turn the valve knob fully towards the lit valve indicator LED until it reaches its stop. If using a GPC1 to adjust pressure, set the GPC1 supply regulator so the GPC1 supply is equal to the DUT full scale pressure (see the GPC1 Operation and Maintenance Manual). Press **[ENT]** when ready to proceed with the test.



*To abort the test but use the RPM4 with the settings for the DUT that was initialized, press **[ESCAPE]** from the **<SET VALVE FOR xx PRT>** screen. This can be useful for setting up the RPM4 to make DUT adjustments or run tests other than the one defined by the AutoTest.*

The display is:

0.0 psi g	Lo
Exercise DUT & [ENT]	

The top line is the standard RPM4 run screen indicating the current measured pressure (see Section 3.1.1). Exercise the DUT if desired using the top line indication of the measured pressure and press [ENT] when complete. The display is:

1. Standard RPM4 run screen indicating current measured pressure.
2. Number of this test point/the total number of test points in the sequence.
3. Pressure to set for this increment in current pressure unit of measure and measurement mode.

0.0 psi g	Lo
Set 0.0	1/11

↓ 1
↑ 3
↑ 2

Adjust the pressure to the <Set nnnn> value indicated. **Set the pressure so that the DUT, NOT the RPM4, indicates the <Set nnnn> value.**

Once the specified pressure has been set, press [ENT]. If the RPM4 pressure reading is in **Not Ready** condition (see Section 3.2.1), the RPM4 makes an invalid entry sound and displays <Pressure NOT READY, TRY AGAIN>. Correct the conditions that are causing the RPM4 reading to be excessively unstable and press [ENT] again. If the RPM4 pressure reading is in **Ready** condition, the RPM4 makes a valid entry sound and the display is:

1. Standard RPM4 run screen indicating current measured pressure.
2. Number of this test point/the total number of test points in the sequence.
3. <F> to indicate freeze (see Section 3.3.6.7) followed by the RPM4 pressure reading in current units of measure captured when [ENT] was pressed in the previous <Set> screen. This is the reference pressure that was applied to the DUT when the DUT indicated the cardinal point. The frozen pressure value flashes if the reading was out of tolerance (definition of out of tolerance is: Set point – RPM4 reading > DUT tolerance)..

497.7 psi g	Lo
F497.6	OT 2/11

↓ 1
↑ 4
↑ 3
↑ 2

Press [ENT] to accept this test point and proceed to the next test point or [←] to repeat the point.

Repeat the set pressure, take reading and accept data procedure until all points in the sequence have been accepted.

After the last pressure point in the sequence has been accepted the display is:

AutoTest complete	
1data	2new 3repeat

Select <1data> to view the data collected in the AutoTest that was just completed (see Section 3.4.5.1).

Select <2new> to run a new Quick or File AutoTest.

Select <3repeat> to repeat the AutoTest that was just completed.

Press [ESCAPE] to return to the main run screen.



## 3.4 [SETUP]

### ○ PURPOSE

[SETUP] accesses a menu of functions and features commonly used in setting up and using RPM4.

### ○ OPERATION

To access the SETUP menu, press [SETUP] from the MAIN RUN screen. The display is:

1range	2res	3stab
4UL	5ATest	

SETUP menu choices include:

- <1range> Save and delete ranges created by AutoRange (see Section 3.4.1).
- <2res> Adjust the resolution of pressure displays (see Section 3.4.2).
- <3stab> Adjust the pressure stability limit that is the criterion for the *Ready/Not Ready* indication (see Section 3.4.3).
- <4UL> Adjust upper pressure limit alarm (see Section 3.4.4).
- <5ATest> Set up File AutoTest files and view data files resulting from running AutoTests (See Section 3.4.5).

### 3.4.1 <1RANGE>

#### ○ PURPOSE

Save AutoRange ranges and associated settings for recall. Delete previously saved AutoRange ranges.

#### ○ PRINCIPLE

The RPM4 AutoRange function creates a range and automatically sets various operating parameters proportionally to the range (see Section 3.3.4). Operating settings can then be changed by the user. Many operating settings are specific to the current range (see Table 2).

[SPECIAL], <1range> allows the AutoRange range and associated settings to be saved for recall using the [RANGE] key (see Section 3.3.1). This can avoid having to recreate frequently used ranges and settings.

[SPECIAL], <1range> is also used to delete ranges that have been saved but are no longer needed.

#### 3.4.1.1 SAVING AN AUTORANGE RANGE

##### ○ OPERATION

To save a range created by AutoRange, the range must be the active range. Use AutoRange or AutoTest to create the range (see Sections 3.3.4, 3.3.10) and then make any desired feature and setting adjustments.

Once the AutoRange range is set up as desired, press [SETUP], <1range>, <1save>. The display is:

1. Indication that this is a range to be saved.
2. Designator and position of the Q-RPT used by the range to be saved.
3. Pressure unit of measure of the range to be saved.
4. Full scale pressure of the range to be saved in gauge mode and absolute mode if available.

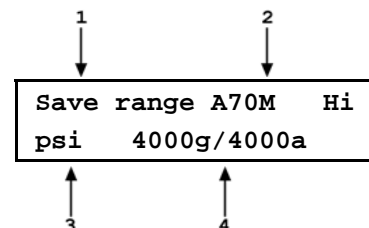

Press **[ENT]** to save the range or **[ESC]** to return to the MAIN RUN screen without saving the range.



Default (<DF>) Q-RPT ranges cannot be saved. They are permanent.

Duplicate AutoRange ranges cannot be saved. A duplicate AutoRange range is a range that has the same measurement mode and full scale and uses the same Q-RPT as a range that has already been saved.

### 3.4.1.2 DELETING AUTORANGE RANGES

#### ○ OPERATION

To delete a single saved AutoRange range, press **[SETUP]**, <1range>, <2delete>. If there are any saved ranges available to delete, the display is:

1. Indication that the cursor control keys may be used to toggle through the saved ranges to select the one to be deleted.
2. Designator and position of the Q-RPT used by the range to be deleted.
3. Pressure unit of measure of the range to be deleted.
4. Full scale pressure of the range to be deleted in gauge mode and absolute mode if available.

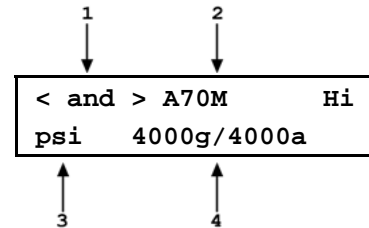

Use the cursor control keys to toggle through the ranges available to be deleted. When the desired range to be deleted is displayed, press **[ENT]**. If you are sure you want to delete this range, press **[ENT]** again in response to the <Delete?> query. **[ESC]** returns to the <AutoRange:> screen without deleting a range.

To delete all of the saved AutoRange ranges, press **[SETUP]**, <1range>, <3delete all>. If you are sure you want to delete all the ranges, respond <1yes> to the <Delete all saved ranges?> query. If not, respond <2no>.

### 3.4.2 <2RES> (RESOLUTION)

#### ○ PURPOSE

To set the resolution with which measured pressures and other pressure indications and settings are displayed.

#### ○ PRINCIPLE

The resolution with which RPM4 displays pressure values can be adjusted. This feature can be used to reduce the resolution when lower precision measurements are being made and excess resolution might confuse or distract the operator.

The resolution setting determines the number of digits with which pressure is displayed. The resolution is calculated based on the span of the range and then rounded to the furthest digit to the right. For example, resolution of 0.001 % on a range of 1 500 psi is  $1\ 500 \times 0.001\ \% = 0.015$  which is rounded down to 0.01 psi.



Default resolution is 10 ppm of active range span. Resolution is set automatically by AutoRange (see Section 3.3.4) and by AutoTest initialization (see Section 3.3.10).

## ○ OPERATION

To access the resolution function, press **[SETUP]**, **<2res>**. The display is:

Display resltn:	Hi
0.0010 %FS	< and >

Use the cursor control keys to set the desired level of resolution. Press **[ENT]** to return to the MAIN RUN screen with the new resolution setting active or **[ESC]** to make no changes.



The resolution setting is range specific. A resolution setting made in one range does NOT affect other ranges.



The maximum resolution setting is limited in AutoRange ranges that are less than 10% of the Q-RPT default full scale.

### 3.4.3 <3STAB>

## ○ PURPOSE

To view and/or adjust the stability test that is the Ready/Not Ready criterion for the active Q-RPT and range.



See Section 3.2.1 Pressure Ready/Not Ready.

## ○ PRINCIPLE

RPM4 continuously monitors the rate of change of pressure measured by the active Q-RPT and compares this rate to the active stability limit to make a *Ready/Not Ready* determination (see Section 3.2.1). The stability function allows the stability limit to be adjusted by the user to increase or decrease the stability required for a *Ready* condition to occur.



Default stability when using AutoRange is  $\pm 0.005\%$  FS of active range span. Default stability when AutoRanging as part of an AutoTest is 10% of the DUT tolerance (see Section 3.3.4, Table 4).



The stability limit is separate and different from the Rate DISPLAY function (see Section 3.3.6.2) which allows the current rate of change of pressure to be displayed.

## ○ OPERATION

To access the stability setting adjustment, press **[SETUP]**, **<3stab>**. The display is:

Stability limit:	Hi
0.5 psi/s	

Edit the desired stability limit setting. **[ENT]** activates the stability limit for the active range and returns to the main run screen. Press **[ESC]** to return to the MAIN RUN screen with no change to the stability limit.



The stability setting is range specific. A stability setting made in one range does NOT affect other ranges.

### 3.4.4 <4UL> (UPPER LIMIT)

#### ○ PURPOSE

To set the upper pressure limit value for a pressure range and measurement mode.

#### ○ PRINCIPLE

The UPPER LIMIT function provides the user with a settable pressure limit at which an alarm sounds.

When the limit is reached, RPM4's beeper sounds intermittently as long as pressure is above the limit.

The UPPER LIMIT function has two purposes. First, when UL is set to its default value, it serves as a warning that the maximum pressure of the active range is about to be exceeded. Second, UL can be set by the user to a value other than the default value to provide an alarm that a specific pressure limit has been exceeded. This feature is often used to help protect a system to which RPM4 is connected. For example, it might be set just over the full scale of a device under test (DUT) that is being calibrated. Note that using AutoRange or AutoTest automatically sets the UL to just above the AutoRange full scale (see Sections 3.3.4, 3.3.10).



*The default upper limit is 105 % of AutoRange span or 102 % of Q-RPT default (maximum) range when AutoTest is used, whichever is lower.*

#### ○ OPERATION

To view or edit upper limit of the active range press **[SETUP]**, **<4UL>**.

The display is:

1. Entry field for upper limit value in active pressure unit of measure and measurement mode.

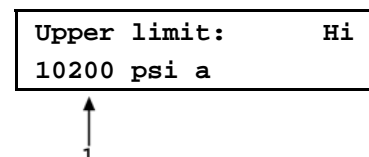

Edit the upper limit value as desired. The maximum upper limit is 105 % of span in an AutoRange range or 102 % of default Q-RPT full scale, whichever is smaller. Press **[ENT]** to return to the MAIN RUN screen with the new upper limit active. Press **[ESC]** to return to the MAIN RUN screen with no change to the upper limit.

When the upper limit has been exceeded, the display of current pressure flashes and a beep sounds for 3 seconds on/2 seconds off intervals. Reduce the pressure applied to RPM4 so that it is below the upper limit to return to normal operation.



*Upper limit values are specific to each range and measurement mode. Be careful not to assume that the upper limit set in one measurement mode will apply to the other. For example, if you change the upper limit in gauge mode, the upper limit will not be changed in absolute mode.*

#### 3.4.4.1 OVER PRESSURE FUNCTION

In addition to the UL function, RPM4 has an over pressure function.

The over pressure function executes when a Q-RPT measures a pressure that is greater than 104 % of the Q-RPT's default span. This is 3120 psi (215.2 MPa) for the A20M Q-RPT and 10400 psi (717.2 MPa) for the A70M Q-RPT.

The over pressure function causes the measured pressure display to flash. The overpressure function also logs the time and date of the overpressure condition in both user and factory logs to assist in incident diagnosis (see Section 3.5.7.5).

To recover from an overpressure condition, cycle RPM4 power. Before cycling power, be sure to correct the condition that caused the overpressure.

### 3.4.5 <5ATEST>

#### ○ PURPOSE

To view data collected while running an AutoTest and/or to view and edit File AutoTest definition files.

See Section 3.3.10, **PRINCIPLE** for information on the AutoTest function.

#### ○ OPERATION

To access the ATest menu select [**SETUP**], <5ATest>. The display is:

Select <1data> to view AutoTest results data (see Section 3.4.5.1).

AutoTest: 1data 2file
--------------------------

Select <2file> to view or edit an AutoTest definition file (see Section 3.4.5.2).

#### 3.4.5.1 DATA

##### ○ PURPOSE

To view the data files that are created when an AutoTest is run.

##### ○ PRINCIPLE

RPM4 supports AutoTest automated tests (see Section 3.3.10). When an AutoTest is run, the RPM4 pressure measurement accepted by the operator at each point is logged. The logged pressure measurements and an identifying header are stored in a data file. The data file can be viewed immediately following the last point of the sequence by selecting <1data>. In addition, the last ten data files recorded can be viewed anytime by selecting [**SETUP**], <5ATest>, <1data>.

##### Data File Protocol

Up to ten data files are buffered, ten at a time, in RPM4 memory. When a new AutoTest run is completed, its data file goes to the back of the queue and the oldest data file is deleted.

Data files are identified by a header whose first line is the full scale of the DUT and the number of test points in the AutoTest. The second line is the date (YYYYMMDD) and time (HH:MM:SS) at which the last point of the sequence was accepted.

Following the data file header, each test point is recorded including the pressure reading of the RPM4 with head, AutoZ and range status as well as an indication of whether the reading was out of tolerance and the test point number over the total number of test points in the Sequence.

##### ○ OPERATION

To access the AutoTest results data file viewing function press [**SETUP**], <5ATest>, <1data>.

The first display is the data file header which can be used to toggle through data files:

1. Full scale of the AutoTest with pressure unit of measure and measurement mode.
2. Number of test points executed/total number of points in the AutoTest.
3. Date and time that the last point in the AutoTest was executed.

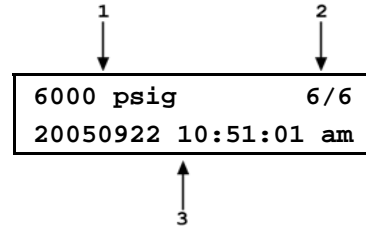

Press **[+/-]** or **[→]** to scroll through the headers of the other AutoTest data files available. RPM4 stores up to ten AutoTest data files in order of execution with a new data file pushing all the files back and deleting the oldest one. When the header of the AutoTest data file you would like to view appears, press **[ENT]** to view the first point of the identified AutoTest data file.

The display is:

1. RPM4 reading logged for the test point.
2. Head, AutoZ and Q-RPT indicator (same as in the RPM4 main run screen) (see Section 3.1.1).
3. Indication that this is an AutoTest data file view screen.
4. **<FA>** indicating that the AutoTest was a File AutoTest or **<QA>** indicating a Quick AutoTest. This is preceded by **<OT>** if the test point was out of tolerance (definition of out of tolerance is Set point – RPM4 reading > DUT tolerance).
5. Number of this test point over total number of points in the AutoTest.

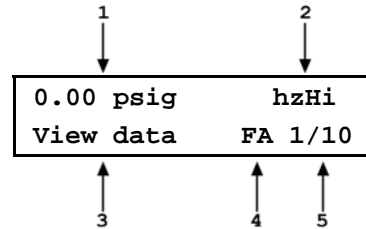

Press **[ENT]** to move to the next data point. Press **[←]** or **[→]** to scroll backward and forward through the test points. The data file header is between the first point and the last point.

Press **[ESC]** to exit the data file. Confirmation is required to exit the data view function.

---

 **Up to ten data files are buffered, ten at a time, in RPM4 memory. When a new AutoTest run is completed, its data file goes to front of the queue and the oldest data file is deleted.**

---

### 3.4.5.2 FILE

#### ○ PURPOSE

To view and edit File AutoTest definition files.

#### ○ PRINCIPLE

RPM4 supports AutoTests (see Section 3.3.10, ○ PRINCIPLE). There are two types of AutoTests:

- Quick AutoTests in which the DUT and test parameters are entered “on the fly” during the initialization of the test.
- File AutoTests in which the DUT and test parameters are stored in a file and retrieved when the file is selected to run an AutoTest.

File AutoTest parameters are stored in definition files. **[SETUP], <5AutoTest>, <2file>** allows File AutoTest definition files to be viewed and edited. Up to 40 File AutoTest definition files with up to 21 test points in each file can be created.

A File AutoTest definition file defines:

- The identifying number of the File AutoTest definition file.
- Pressure measurement mode (gauge or absolute).
- Pressure unit of measure.
- DUT full scale in pressure unit of measure and measurement mode.
- DUT tolerance (% FS).
- Number of test points or pressure targets to include in the AutoTest.
- Numerical value of each test point or pressure target.

See Section 3.3.10, **O OPERATION** for information on running a Quick or File AutoTest.

See Section 3.4.5.1 for information on viewing the data files that result from running a Sequence.

### **O OPERATION**



See Section 3.3.10, **OPERATION**, for information on **RUNNING** a Quick or File AutoTest.

To access the AutoTest definition viewing and editing functions press **[SETUP]**, **<5A Test>**, **<2file>**. Select **<1view>** to view an AutoTest definition file. Select **<2edit>** to edit an AutoTest definition file.

When **<2edit>** is selected the display is:

```

Edit File AutoTest #
1
  
```

Enter the number (1 - 40) of the File AutoTest to be edited.



To create a File AutoTest definition file similar to an existing definition file without entering all the definition information, edit an existing definition file and at the end of the editing process, save it as a different file number.

The display is:

```

Measurement mode:
1absolute 2gauge
  
```

The cursor is on the current selection. Select the desired pressure measurement mode for the AutoTest (see Section 3.3.3).

The display is:

```

1psi 2MPa 3kPa
4bar
  
```

The unit of measure selection screen is the current **[UNIT]** selection screen (see Section 3.3.2). Select the desired pressure measurement unit for the AutoTest.

The display is:

```

DUT full scale:
6000 psi g      File1
  
```

Enter the full scale pressure of the DUT to be calibrated with this File AutoTest. The value entered will be used along with the DUT tolerance to AutoRange RPM4 settings when the File AutoTest is run (see Section 3.3.10, **O PRINCIPLE**).

The display is:

```

DUT tolerance:
0.25% FS      File1
  
```

Enter the tolerance in % of full scale (measurement uncertainty, precision or accuracy as desired) of the DUT to be calibrated using this File AutoTest. The value entered will be used along with the DUT full scale to determine RPM4 AutoRange settings when the AutoTest is run (see Section 3.3.10, **O PRINCIPLE**).

The display is:

```
Number of targets:
1                File1
```

Enter the total number of pressure points or target pressures to be included in the AutoTest. The maximum number of points is 21. If data is to be taken at “zero” pressure, include the “zero” points in the point count.

The display is:

```
Pressure target N:
0.00 psi g      File1
```

Enter the numerical value of the target pressure point <N>. Repeat until all of the points in the File AutoTest have been defined.

After entering the last pressure target, the display is:

```
Save as File
AutoTest #:1
```

Enter the identifying number under which this File AutoTest definition file should be saved. A confirmation is required to overwrite an existing sequence.

While editing a File AutoTest, pressing **[ESC]** backs through entries until editing of the pressure target values has begun. Then **[ESC]** can only be used to abandon editing.

## 3.5 [SPECIAL]

### **O PURPOSE**

**[SPECIAL]** accesses a menu of RPM4 functions and features that are less commonly used or not normally used in regular operation.

### **O OPERATION**

Press **[SPECIAL]** from the MAIN RUN screen to access the SPECIAL menu. The display is:

```
1AutoZ 2remote 3head
4SDS 5prefs 6Punit ↓
7intern 8cal 9reset
```



*Some screens, such as the SPECIAL menu, go beyond the two lines provided by the display. This is indicated by a flashing arrow in the second line of the display. Press the cursor control keys to move the cursor to access the lines that are not visible or directly enter the number of the hidden menu choice if you know it.*

SPECIAL menu choices include:

- <1AutoZ>** Manage the AutoZero function for the active Q-RPT (see Section 3.5.1).
- <2remote>** View and edit COM port (RS-232) and IEEE-488 interface settings. Select remote syntax style (see Section 3.5.2).
- <3head>** Set HEAD function fluid and height unit of measure (see Section 3.5.3).
- <4SDS>** Feature not used in this RPM4 model.
- <5prefs>** View and set screen saver time, keypad sound frequency, unit ID number, time/date, security protection level (see Section 3.5.5).
- <6Punit>** Customize the **[UNIT]** key pressure unit of measure selections (See section 3.5.6).



- <7intern> Access internal functions including on-board barometer viewing, read rate adjustment, incident log viewing (see Section 3.5.7).
- <8cal> View and adjust RPM4 Q-RPT and barometer calibration coefficients (see Sections 3.5.8, 5.2, 5.3).
- <9reset> Access RPM4's various reset functions (see Section 3.5.9).

### 3.5.1 <1AutoZ>

#### ○ PURPOSE

To turn ON and OFF the AutoZ function that offsets the RPM4 Q-RPT readings relative to a reference value in order to compensate for possible Q-RPT zero drift between full recalibrations. To view and adjust the value of the AutoZ offset.



To RUN the AutoZ routine that rezeroes the Q-RPT, use [AutoZ] (see Section 3.3.9).

#### ○ PRINCIPLE

##### AutoZ Purpose and Principle

The main component of the change over time of the RPM4 Q-RPTs is change in zero or offset, independent of span. Offsetting or “rezeroing” RPM4 Q-RPTs relative to a reference between recalibrations allows measurement uncertainty specifications to be maintained with less frequent full calibrations. The RPM4 AutoZero function (AutoZ) provides full on-board support for the rezeroing process to simplify its regular application by the user.

The AutoZero function uses three values:

1.  $P_{std,0}$ : The pressure value indicated by the AutoZ reference, the device that is acting as the reference relative to which to offset the RPM4 Q-RPT.

**In absolute measurement mode**, the pressure at which AutoZ is performed is normally atmospheric pressure and the  $P_{std,0}$  value can be supplied a) by manual entry, b) automatically from a DHI RPMx connected to RPM4's COM2 communications port, or c) automatically from the Lo Q-RPT for the Hi Q-RPT.

**In gauge measurement mode**,  $P_{std,0}$  is always zero (atmospheric pressure) which is supplied by definition when the Q-RPT is vented to atmosphere.

2.  $P_{u,0}$ : The pressure reading of the Q-RPT, with no AutoZ offset, at the time AutoZ is performed.
3.  $P_{offset,G}$  and  $P_{offset,A}$ : The difference between the reading of the Q-RPT with no AutoZ offset ( $P_{u,0}$ ) and the AutoZ standard ( $P_{std,0}$ ) for gauge (G) and absolute (A) measurement mode:

$$P_{offset} = P_{u,0} - P_{std,0}$$

$P_{offset}$  represents the difference between the Q-RPT reading ( $P_{u,0}$ ) and the AutoZ standard ( $P_{std,0}$ ). The AutoZ function manages the determination, storage and application of  $P_{offset}$  to correct the zero offset in absolute and gauge measurement modes.

When the Q-RPT is calibrated,  $P_{offset}$  is set to zero.  $P_{offset}$  is then redetermined at regular intervals using the AutoZ function. The most recent value of  $P_{offset}$  is applied to the Q-RPT reading to correct for zero drift.

The AutoZ function can be turned ON and OFF. Table 5 summarizes the effect of AutoZ ON and OFF in absolute and gauge measurement modes.

##### AutoZ in absolute measurement mode

The RPM4 A70M/A20M-AF Q-RPTs are intrinsically absolute. They have an evacuated and sealed reference and naturally measure absolute pressure (difference from vacuum).

In absolute measurement mode, the source of  $P_{std,0}$  must be an absolute pressure, nominally atmospheric pressure, with uncertainty significantly better than that of the Q-RPT that is

being AutoZeroed. Given the high pressure range of the RPM4 Q-RPTs, adequate uncertainty is easily available from a variety of digital barometers or, for the Hi Q-RPT, by the Lo Q-RPT.

In absolute measurement mode, with AutoZ ON, absolute pressure is calculated as:

$$P_{abs} = P_u - P_{offset,A}$$

In absolute measurement mode, running the AutoZ function to update the AutoZ value ( $P_{offset,A}$ ), is initiated by the operator using **[AutoZ]** (see Section 3.3.9.1).

**AutoZ in gauge measurement mode, dynamic compensation for atmospheric pressure**

The RPM4 A70M/A20M-AF Q-RPTs are intrinsically absolute but they are also used in gauge measurement mode (difference from atmosphere). Gauge measurement mode is achieved by subtracting the value of atmospheric pressure from the Q-RPT’s absolute reading using AutoZ and by dynamically compensating for changes in atmospheric pressure between opportunities for AutoZ to execute (see Section 3.2.2, **O PRINCIPLE**).

In gauge measurement mode, the value of  $P_{std,0}$  is always zero gauge pressure. Zero gauge pressure, by definition, is applied to the Q-RPT when it is vented to atmosphere. Gauge pressure is the measured absolute pressure,  $P_u$ , minus  $P_{offset,G}$ .

$$P_{gauge} = P_u - P_{offset,G}$$

When AutoZ is ON, dynamic compensation for atmospheric pressure is also applied to compensate for changes in atmospheric pressure as measured by RPM4’s on-board barometer ( $\Delta P_{atm}$ ) between AutoZ updates (see Section 3.2.2). The measured gauge pressure is calculated using  $\Delta P_{atm}$  to correct the value of  $P_{offset,G}$ .

$$P_{gauge} = P_u - P_{offset,G} - \Delta P_{atm}$$

In gauge measurement mode, running AutoZ is initiated by the operator pressing **[AutoZ]** (see Section 3.3.9.1) when the RPM4 is vented. This assures regular updating of the value of  $P_{offset,G}$  and  $P_{atm,0}$ .  $\Delta P_{atm}$  is continuously updated automatically.



*When gauge mode is first activated, the value of  $P_{offset,G}$  subtracted from the absolute pressure reading to achieve gauge pressure is standard atmosphere of 101.325 kPa. This can cause a large zero error when gauge mode is activated if atmospheric pressure is significantly different from standard atmospheric pressure. When gauge mode is activated, always vent the RPM4 Q-RPT and press **[AutoZ]** to run AutoZ and obtain an actual value of  $P_{offset,G}$ .*

**AutoZ ON/OFF**

The AutoZ function can be turned ON and OFF separately for gauge and absolute measurement modes. Table 5 summarizes the effect of AutoZ ON and OFF. Generally, AutoZ should always be left ON.

**Table 5.** AutoZ ON and OFF

MEASUREMENT MODE	AutoZ STATUS	$P_{offset}$ APPLIED	$\Delta P_{atm}$ APPLIED	AutoZ ROUTINE RUNS
Absolute	ON	YES	Not Applicable	When initiated by operator
	OFF	NO		Not available
Gauge	ON	YES	YES	When initiated by operator
	OFF		NO	

### Recommendations for the Use of the AutoZ Function

The AutoZ function provides a powerful and easy to use tool for improving the stability over time of RPM4 Q-RPTs and maximizing the recalibration interval by compensating for zero drift between full recalibrations. The following simple recommendations will help assure that you use this feature to best advantage.

- **In gauge mode:** Always leave AutoZ ON. Use **[AutoZ]** to run AutoZ whenever RPM4 is vented and displays a significantly non-zero value. Wait at least 2 minutes after venting before running AutoZ.
- **In absolute measurement mode:** Always leave AutoZ ON. Use **[AutoZ]** to run AutoZ every approximately every 30 days or when RPM4 has been exposed to a temperature change exceeding 15 °C (36 °F). AutoZero the Lo Q-RPT against a barometer with measurement uncertainty of  $\pm 0.04$  psi (275 Pa) or better (note that this is only 0.3% of atmospheric pressure so a relatively low accuracy barometer is adequate). AutoZero the Hi Q-RPT against the Lo Q-RPT. Wait 5 to 10 minutes before running AutoZero in absolute mode.

### ○ OPERATION



The AutoZ function and values are Q-RPT AND measurement mode (gauge or absolute) specific.



To RUN the AutoZ routine that zeroes the Q-RPT, use **[AutoZ]** (see Section 3.3.9).

To access the RPM4 AutoZ function press **[SPECIAL]**, **<1AutoZ>**. The display is:

1. Active Q-RPT designator.
2. Indication of active measurement mode (**<abs>** for absolute, **<gage>** for gauge).
3. Indication of whether AutoZ is currently ON or OFF for this Q-RPT and measurement mode.

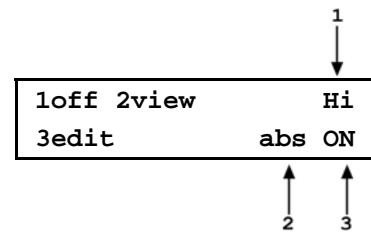

Select **<1off>** (or **<1on>**) to change the AutoZ status for the current Q-RPT and measurement mode from ON to OFF or vice versa.



AutoZ ON is indicated by a **<z>** in the MAIN RUN screen, top line, third character from the right. When AutoZ is OFF, the character is blank.

Select **<2view>** to view the current value of  $P_{\text{offset}}$  for the active Q-RPT and measurement mode.



$P_{\text{offset}}$  should be zero in absolute measurement mode when the RPM4 is new or has just been calibrated.  $P_{\text{offset}}$  should be roughly equal to atmospheric pressure when the Q-RPT is in gauge measurement mode.

Select **<3edit>** to edit the value of  $P_{\text{offset}}$  for the active Q-RPT and measurement mode (see Section 3.5.1.1).



The value of  $P_{\text{offset}}$  is always displayed and entered in Pascal (Pa).

### 3.5.1.1 EDIT AUTOZ



The edit AutoZ function should be used only with great care as entering inappropriate values may result in out of tolerance measurements. In normal operation, the value of the AutoZ offset,  $P_{offset}$ , should be changed by running AutoZ using [AutoZ] (see Section 3.3.9). Before editing  $P_{offset}$ , see Section 3.5.1, ○ PRINCIPLE.

To edit the current  $P_{offset}$  value for the active Q-RPT and measurement mode, press [SPECIAL], <1AutoZ>, <3edit>. The display is:

1. Indication of active measurement mode (<abs> for absolute, <gage> for gauge).
2. Active Q-RPT for which  $P_{offset}$  is being viewed.
3. Edit field for value of  $P_{offset}$ .

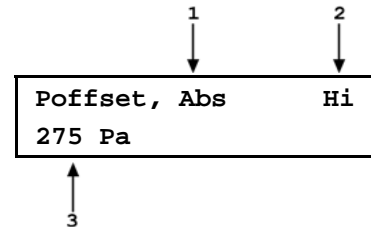

Edit  $P_{offset}$  as desired and press [ENT] to activate the new value. Press [ESC] to abandon changes.



The value of  $P_{offset}$  is always displayed and entered in Pascal (Pa).

### 3.5.2 <2REMOTE>

#### ○ PURPOSE

To configure the RPM4 COM1, COM2 and IEEE-488 (GPIB) communication ports. To test COM1 and COM2 communications. To select the remote programming communications format.

#### ○ PRINCIPLE

The RPM4 has two RS-232 communications ports referred to as COM1 and COM2 and a single IEEE-488 (GPIB) port. COM1 or the IEEE-488 port is for communicating with a host computer (see Section 4), and COM2 is reserved for communicating with an external device (e.g. an RPMx, a multimeter, etc.). These ports' settings can be viewed and changed using [SPECIAL], <2remote>.

RPM4 has two remote communications formats, classic and enhanced (see Section 4.3). The active format can be selected.

A self test is supplied for RS-232 communications. The self test allows verification that the RPM4 RS232 ports (COM1 and COM2) are operating properly and that a valid interface cable is being used.

#### ○ OPERATION

To access the communications settings, press [SPECIAL], <2Remote>.

- Select <1COM1> to view and edit COM1 settings (see Section 3.5.2.1.).
- Select <2COM2> to view and edit COM2 settings (see Section 3.5.2.1.).
- Select <3IEEE> to view and edit IEEE-488 settings (see Section 3.5.2.2.).
- Select <4format> to select the remote communications command format (see Section 3.5.2.3.).
- Select <5RS232test> to run the COM1 and COM2 communications test (see Section 3.5.2.4.).

### 3.5.2.1 <1COM1, 2COM2>

The COMx ports can be set for specific communications settings. The settings are baud rate, parity, data bits and stop bits. The available options are:

**Baud** 300, 600, 1 200, 2 400, 4 800, 9 600, 19 200, 28 800, 38 400

**Parity** NONE, ODD or EVEN

**Length** 7 or 8

**Stop Bit** 1 or 2

The default is <2 400, E, 7,1> for both COM1 and COM2.

The user can also specify one or two termination characters, referred to as "Term1" and "Term2", as well as define these characters. These define the characters that mark the end of commands that are sent to the RPM4 as well as mark the end of replies sent back to the host computer. The RPM4 typically uses the <Term1> character to mark the end, and will ignore the <Term2> character. The characters can be any decimal number from 1 to 255. The defaults are <13> (carriage return) and <10> (line feed) and usually should not be changed.

### 3.5.2.2 <3IEEE-488>

The IEEE-488 port's primary address can be set from 1 to 31 in this screen. The factory default value is 10. Secondary addressing is not used or supported. This address must not conflict with the address of any other device on the same IEEE-488 bus.

The receiving terminating character must be a line feed and EOI. Carriage returns are ignored if received. The RPM4 sends a line feed and asserts the EOI line to terminate a reply. These settings are fixed to agree with IEEE Std. 488.2. If you change the address, the IEEE interface will reset (PON) and become idle.

### 3.5.2.3 <4FORMAT>

The RPM4 has two different syntax formats available for the remote program commands.

The **classic** remote command format is highly intuitive and conforms with previous **DHI** PPC and RPM products.

The **enhanced** remote command format generally uses the same commands as the **classic** format, but in addition it follows the syntax, format, and status reporting features of IEEE Std 488.2.

The details of each format are covered in Section 4.3.

**[SPECIAL]**, <2remote>, <4format> allows the remote program command syntax to be selected. The cursor is on the active format. Select <1classic> or <2enhanced> as desired.

### 3.5.2.4 <5RS232 SELF-TEST>

The RS232 self-test is provided to check the RPM4 COM ports and the interface cable independently of an external device or computer.

**If you are having difficulty communicating with RPM4 from a host computer using RS232**, the RS232 self test can help establish that the RPM4 COM1 port you are trying to communicate with and the interface cable you are using are good.

To run a self test of the RS232 ports (COM1 and COM2), press **[SPECIAL]**, <2remote>, <5RS232test>.

The display prompts you to connect COM1 to COM2 using a standard pin-to-pin DB-9F to DB-9M RS232 cable (see Section 4.2.1.1, 4.2.1.3).

Once the cable has been installed, press **[ENT]** to run the self-test. The test is first executed in the COM1→COM2 direction and then in the COM2→COM1 direction.

**If the COM1→COM2 test passes:** **<PASSED>** displays briefly and the test proceeds to COM2→COM1.

**If COM2→COM1 passes:** **<PASSED>** is displayed briefly followed by the conclusion, **<The RS232 test has PASSED>**.

**If a test fails:** Execution is suspended until **[ENT]** is pressed.

---



The RPM4 RS232 test can fail for three reasons:

1. The RS232 cable being used is incorrect (Section 4.2.1.1, 4.2.1.3 for information on the correct cable).
2. COM1 and COM2 do NOT have the same serial communications settings and therefore cannot communicate together (see Section 3.5.2.1 to set the COM ports).
3. COM1 or COM2 is defective.

The reason for failed communications is almost always a cable or incorrect RS232 interface settings. Be sure that these are correct before concluding that a COM port is defective.

---

### 3.5.3 <3HEAD>

#### ○ PURPOSE

To view or change the properties of the HEAD function (see Section 3.3.7) including the unit of measure of length for head height entry and the test fluid type and species for density calculations.

#### ○ OPERATION

From the MAIN RUN screen, press **[SPECIAL]**, **<3Head>**.

Select the desired height unit of measure and press **[ENT]**.

Select **<1gas>** or **<2liquid>** depending on the pressurized medium between the RPM4 and the height at which pressure is to be calculated. Select the gas or liquid species. The liquid selection **<3User>**, is to create a custom liquid with a user entered density.

Use **[HEAD]** to set a head height if desired.

### 3.5.4 <4SDS>

#### ○ PURPOSE

This feature is not used in RPM4 A70M/A20M-AF.

### 3.5.5 <5PREFS>

#### ○ PURPOSE

To access a menu of RPM4 operational preferences and functions.

#### ○ OPERATION

To access the PREFS menu press **[SPECIAL]**, **<5prefs>**. The display is:

1scrSvr	2sound	3time
4ID	5level	

The PREFS menu includes:

- <1ScrSvr>** View and change the screen saver activation time (see Section 3.5.5.1).
- <2sound>** View and change the key press sounds (see Section 3.5.5.2).
- <3time>** View and edit the internal time and date settings (see Section 3.5.5.3).
- <4ID>** View the RPM4 serial number (SN) and view or edit the ID number (see Section 3.5.5.4).
- <4level>** View and set the user security level and/or password (see Section 3.5.5.5).

#### 3.5.5.1 <1SCRSVR>

##### ○ PURPOSE

To adjust the idle time after which RPM4's SCREEN SAVER activates.

##### ○ PRINCIPLE

RPM4 has a SCREEN SAVER function which causes the display to dim after a front panel key is NOT pressed for a certain amount of time. The default is for the screen saver to activate after 10 idle minutes. The screen saver activation time can be adjusted by the user or screen saving can be completely eliminated.



*Setting screen saver time to zero eliminates the SCREEN SAVER function so that the display permanently remains at full brightness.*

##### ○ OPERATION

To access the SCREEN SAVER function, press **[SPECIAL]**, **<5prefs>**, **<1ScrSav>**. Edit, in minutes, the idle time after which screen saver will activate to dim the screen. Set the time to zero to eliminate the SCREEN SAVER function.

#### 3.5.5.2 <2SOUND>

##### ○ PURPOSE

To adjust or suppress the RPM4 valid key press sound.



*See Section 3.1.4 for information on the complete list of sounds made by RPM4 and their meanings.*

##### ○ PRINCIPLE

RPM4 provides audible feedback by a brief “beep” when a valid key press is made. The tone frequency of this beep may be selected from three choices or it may be completely suppressed. Invalid key presses are indicated by a descending two tone “blurb” which cannot be suppressed.

##### ○ OPERATION

To access the keypad sound adjustment function press **[SPECIAL]**, **<5prefs>**, **<2sound>**.

Select between **<2lo>**, **<3mid>** or **<4hi>** to adjust the valid key press tone frequency.

Select **<1none>** to suppress the valid key press tone.



The sound function only affects the valid key press tone. The invalid key press tone and other RPM4 sounds cannot be adjusted or suppressed.

---

### 3.5.5.3 <3TIME>

#### ○ PURPOSE

To view and edit the RPM4 internal time and date settings.

#### ○ OPERATION

To access the TIME function press **[SPECIAL]**, **<5prefs>**, **<3time>**.  
The display is:

Edit: 1time 2date
08:32:11 am 20030125

Select **<1time>** to edit the time. Edit hours, then minutes, then am/pm by pressing **[ENT]** after each entry. Seconds go to zero when minutes are entered. This can be used to synchronize the time with a time standard.

Select **<2date>** to edit the date. The date must be specified in YYYYMMDD format.

---



The RPM4 date and time are set to United States Mountain Standard Time in the final test and inspection process at the factory. If desired, use the TIME and DATE function to set your local time and date.

---

### 3.5.5.4 <4ID>

#### ○ PURPOSE

To view or edit the RPM4 user ID and to view the RPM4 serial number.

#### ○ OPERATION

To access the ID function press **[SPECIAL]**, **<5prefs>**, **<2ID>**.

Select **<1view>** to view the current ID.

Select **<2edit>** to edit the ID.

The ID has twelve characters. When the edit screen is opened, the cursor is on the first character. Numerical values can be entered directly from the keypad. In addition, the cursor control keys can be used to toggle through a list of available alphanumeric characters. Holding the key slews through the characters. Character order going up is: blank space, symbols, lower case letters, upper case letters, numbers. After selecting a character, press **[ENT]** to activate it and move to the next character field.

When a character is selected the cursor moves to the next character. To leave a blank character, press **[ENT]** with the field for that character blank. Use this for the trailing characters if the ID being entered is less than twelve characters.

After the last of the twelve characters has been entered, the **<Save ID?>** option is offered. Select **<1no>** to return to the ID edit screen. Select **<2yes>** to save the edited ID.

---



The ID can be set remotely from a computer which is quite a bit more convenient than entering characters from the keyboard (see Section 4.4.4, "ID" command). The ID is not cleared or reset by any RESET function (see Section 3.5.9).

---



---

### 3.5.5.5 <5LEVEL> (SECURITY)

#### ○ PURPOSE

To set user protection levels to restrict access to certain functions and to edit the password required for changing user levels.

#### ○ PRINCIPLE

RPM4's front panel user interface provides the means to access all RPM4 user defined data, settings and functions including calibration data. Inadvertent, uninformed or unauthorized altering or deleting of data, settings and functions could require extensive reconfiguration by the user and might cause invalid readings and behavior. For these reasons, depending upon the application in which RPM4 is being used, it may be desirable to restrict access to some functions. The user level function provides a means of restricting access to certain functions. Four different levels of security are available.

Access to changing security levels can be left open, or be protected by a password.

#### Security Levels

The security levels are structured to support typical operating environments as follows:

- |               |   |
|---------------|---|
| <b>None</b>   | This level is intended for use only by the system manager and/or calibration facility. It allows access and editing in all areas including critical metrological information.   |
| <b>Low</b>    | Low security is designed to protect the specific metrological information and SYSTEM DIAGNOSTIC AND MAINTENANCE functions of the system against accidental alteration. It is intended for an advanced operator performing many different tasks. Low security is the default user level setting. |
| <b>Medium</b> | Medium security is designed to protect specific metrological information in the system and to assure that the RPM4 is operated using consistent operational parameters.   |
| <b>High</b>   | High security is designed to protect all operating parameters. It is intended to minimize operator choices, for example to perform repeated identical calibrations under consistent conditions.   |



*RPM4 is delivered with the security level set at low to avoid inadvertent altering of critical internal settings but with access to changing security levels unrestricted. It is recommended that the low security level be maintained at all times. If there is a risk of unauthorized changing of the security level, changing authority should be password protected (see ○ OPERATION of this section).*

---

The security levels are structured to support typical levels of operation as shown in Table 6. Specifically, the security levels prevent execution of the functions accessed by the key strokes marked by “•”:

**Table 6.** Security levels

FUNCTION	LOW	MEDIUM	HIGH
[RANGE]			•
[ENT] (AutoTest)			•
[UNIT]			•
[MODE]			•
[AutoRange]		•	•
[LEAK CK]			•
[DISPLAY]		•	•
[HEAD]			•
[SDS] (NOT USED IN THIS RPM4 MODEL)			
[AutoZ] (in absolute mode)		•	•
[SETUP]			•
[SETUP], <1range>		•	•
[SETUP], <2res>		•	•
[SETUP], <4UL>		•	•
[SETUP], <5ATest>		•	•
[SPECIAL]			•
[SPECIAL], <1AutoZ>		•	•
[SPECIAL], <1AutoZ>, <1on/1off>	•	•	•
[SPECIAL], <1AutoZ>, <3edit>	•	•	•
[SPECIAL], <2remote>			•
[SPECIAL], <2remote>, make changes		•	•
[SPECIAL], <3head>		•	•
[SPECIAL], <4SDS> (NOT USED IN THIS RPM4 MODEL)		•	•
[SPECIAL], <5pref>, <1ScrSvr>		•	•
[SPECIAL], <5pref>, <2sound>		•	•
[SPECIAL], <5pref>, <3time>		•	•
[SPECIAL], <5pref>, <3time>, make changes	•	•	•
[SPECIAL], <5pref>, <4ID>, <2edit>	•	•	•
[SPECIAL], <6Punit>		•	•
[SPECIAL], <7internal>		•	•
[SPECIAL], <7internal>, <3RPT2x> (NOT USED)	•	•	•
[SPECIAL], <7internal>, <5log>, clear log	•	•	•
[SPECIAL], <8cal>		•	•
[SPECIAL], <8cal>, <2edit> under any selection	•	•	•
[SPECIAL], <4reset>		•	•
[SPECIAL], <4reset>, <4cal>	•	•	•
[SPECIAL], <4reset>, <5all>	•	•	•
Remote communications disabled			•

“•” indicates the function/menu is NOT accessible.

## ○ OPERATION

RPM4 is delivered with no active password and access to the User Level menu is open. The user level is set to **<1Low>**. User levels can be changed freely until a password has been created.

To access the LEVEL function press **[SPECIAL]**, **<5prefs>**, **<5level>**. The display is:

```
1change user level
2edit password
```

Selecting **<1change user level>** brings up the restriction menu:

```
Restrictions: 1none
2low 3medium 4high
```

The cursor is on the current restriction level. Select a different level or **[ESC]** back to the MAIN RUN screen.

If no password is active, selecting **<2edit password>** displays the user password and allows it to be edited.

```
Password: pppppp
0 disables password
```



*Once a password has been entered, the user level cannot be changed without reentering the password.*

Passwords can be up to six numbers in length and cannot start with a zero. If **<0>** is entered, the password is made inactive and the user will not be required to enter a password to access the user level menu. This condition, with a security level of **<2low>**, is the factory default.

If there is an active password, the RPM4 password entry screen appears. The user must enter the user defined password or the factory secondary password to proceed further:

```
RPM4 SNnnnn-xx
Password: pppppp
```

The first field, **<nnnn>**, is the serial number of the RPM4, followed by a second field, **<xx>**, that represents the number of times that a secondary password has been used. The second field, **<xx>**, increments each time a secondary password is used. The third field, **<pppppp>** is for user entry of the normal password.



*The factory secondary password is available in case the user's password has been misplaced or forgotten. It can be obtained by contacting a DHI Authorized Service Center (see Table 23). The factory secondary password is different for all RPM4's and changes each time it is used.*

### 3.5.6 <6PUNIT>

#### ○ PURPOSE

To customize the selection of pressure units of measure that are available in the **[UNIT]** key menu.

#### ○ PRINCIPLE

The **[UNIT]** function key makes available a choice of four default pressure units (psi, MPa, kPa, bar) (see Section 3.3.2). RPM4 also supports many commonly used units other than those included in the default set up. These units can be made available for active selection by customizing the UNIT function using **[SPECIAL]**, **<6PresU>**. This allows RPM4 to offer a very wide selection of units while simplifying day to day operation. The typical user

customizes the [UNIT] function key to support his/her most commonly used units. Up to six units can be included in the [UNIT] screen.

**○ OPERATION**

To customize the [UNIT] function key, press [SPECIAL], <6PresU> from the MAIN RUN screen. The display is:

1. Entry field to specify which unit position (1 to 6) of the [UNIT] function key menu is to be changed.

↓  
1

Set up unit #6

Enter the number of the unit position that you would like to change. The display becomes:

Unit#6 1SI 2other  
3altitude 4user

Select the desired pressure unit category (SI units include units based on SI units such as mmHg), then select the desired unit from the unit menu. Note: <3altitude> is not available in this RPM4 model.

The units of measure available are listed in Table 7.

**Table 7.** UNIT function - available units of measure

<1SI>	<2OTHER>	<3ALTIUDE >	<4USER>
<1Pa> <2hPa> <3kPa> <4MPa> <5mbar> <6bar> <7mmHg> <8mmWa>	<1psi> <2psf> <3inHg> <4inWa> <5kcm2>	Not available in this RPM4 model	

If <4user> is selected, the user unit must be defined. The display is:

1. Entry field.

Define user unit:  
1.000000 unit/Pa

↑  
1

Enter the number of user units per Pascal (Pa) in the entry field. Pressing [ENT] defines the user unit and returns to the <Set up unit #n> screen.

---

The user defined unit label can be customized to any alphanumeric, four character label using the remote command "UDU" (see Section 4.4.4).

---

See Section 7.1.1 for the pressure unit conversion factors used by RPM4.

---

### 3.5.7 <7INTERNAL>

**○ PURPOSE**

To view, set, adjust, and maintain various aspects of RPM4's internal operation.

**○ OPERATION**

To access the internal selections press [SPECIAL], <7internal>. The display is:

1baro 2ReadRt 3RPT2x  
4lo vnt 5log

The INTERNAL menu choices include:

- <1baro>** View the real time output of the RPM4 on-board barometer (see Section 3.5.7.1).
- <2ReadRt>** Turn ON and OFF RPM4's automated, rate of change dependent, reading and integration and display rate feature (see Section 3.5.7.2).
- <3RPT2x>** Feature not used in this RPM4 model.
- <4lo vnt>** Feature not used in this RPM4 model.
- <5log>** View the RPM4 incident log (see Section 3.5.7.5).

### 3.5.7.1 <1BARO>

#### ○ PURPOSE

To view the value of atmospheric pressure as measured by the RPM4 on-board barometer.

#### ○ PRINCIPLE

RPM4 A70M/A20M-AF is equipped with an on-board barometer. The atmospheric pressure measurements made by the on-board barometer are used for dynamic compensation of atmospheric pressure when making gauge pressure measurements (see Sections 3.2.2, 3.3.3, ○ PRINCIPLE).



*See Section 5.4.4 Figure 13 and Section 5.4.5, Figure 14 for a photo and schematics showing the position of the on-board barometer in RPM4.*



*The on-board barometer is a low accuracy sensor used only for measuring small changes in atmospheric pressure over short periods of time (see Section 3.2.2). RPM4 measurement uncertainty does not depend on the measurement uncertainty of the on-board barometer.*

#### ○ OPERATION

To view the current reading of the on-board barometer press **[SPECIAL]**, **<7internal>**, **<1baro>**. The display is in the active pressure unit of measure (see Section 3.3.2). The display resolution is fixed to 0.1 Pa, or its equivalent.

### 3.5.7.2 <2READRT>

#### ○ PURPOSE

To turn ON and OFF RPM4's automated, rate of change dependent, reading integration and display rate feature.

#### ○ PRINCIPLE

To obtain maximum resolution from RPM4 Q-RPT pressure measurements, an integration time of about 1.2 second per reading is used. In most situations, maximum precision is needed when pressures are stable so a relatively slow display update rate presents no disadvantage. However, when pressure is changing quickly, more rapid pressure updates are usually more important than obtaining maximum precision on individual readings. The RPM4 read rate function automatically adjusts pressure measurement integration time depending on the rate of change of pressure. When pressure is changing rapidly, reading rate is increased. When pressure is evolving slowly, reading rate is decreased and maximum precision is obtained.

When the automated read rate function is ON, three pressure rate of change dependent read rates are used. The result is three display update rates:

**Table 8.** READRT - display update rates

PRESSURE RATE OF CHANGE	DISPLAY UPDATE
> 3 % of range span/s	≈ 0.2 s
> 0.5 and < 3 % of range span/s	≈ 0.6 s
< 0.5 % of range span/s	≈ 1.2 s

For situations in which maximum reading precision is desired regardless of pressure rate of change, the RPM4 automated read rate function can be turned OFF. In this case, the reading rate is always the high resolution rate of about 1.2 seconds per reading.

### ○ OPERATION

To turn the automated read rate function ON or OFF or check its current status, press **[SPECIAL]**, **<7internal>**, **<3ReadRt>**.

The display is:

```
Auto read rate:  H3
1on 2off
```

The cursor is on the current selection.

Selecting **<1on>** activates the automated reading rate and returns to the MAIN RUN screen. Selecting **<2off>** turns OFF the automated reading rate and returns to the MAIN RUN screen.

The default RPM4 condition is auto read rate ON.



*Auto read rate ON/OFF is NOT Q-RPT or range specific. Turning auto read rate ON or OFF in one range turns it ON or OFF for all RPM4 ranges.*

### 3.5.7.3 <3RPT2x>

#### ○ PURPOSE

This feature is not used in this RPM4 model.

### 3.5.7.4 <4LO VNT>

#### ○ PURPOSE

This feature is not used in this RPM4 model.

### 3.5.7.5 <5LOG>

#### ○ PURPOSE

To view and/or clear the RPM4 event log.

#### ○ PRINCIPLE

RPM4 records to a log each time one of the following events occurs:

- Pmax! of an internal RPM4 Q-RPT is exceeded (see Section 3.4.4.1).
- A memory fault occurs.

### ○ OPERATION

To view the event log press **[SPECIAL]**, **<7internal>**, **<5log>**. The oldest logged event appears. Pressing **[ENT]** steps through the logged events from the oldest to the most recent and ending with the option to clear the log, **<1no>**, **<2yes>**. The log clear choice is not available in all security levels (see Section 3.5.5.5, Table 6).

When all events have been viewed, **<End of log>** displays.

### 3.5.8 <8CAL>

#### ○ PURPOSE

To calibrate the RPM4 Hi and Lo Q-RPTs and adjust the on-board barometer. These functions are considered part of RPM4 maintenance and are covered in the maintenance section of this manual (see Sections 5.2, 5.3).

### 3.5.9 <9RESET>

#### ○ PURPOSE

To reset various RPM4 settings to default or factory values.

#### ○ PRINCIPLE

RPM4 stores its user definable settings in non-volatile memory. The reset menu allows the user to selectively or completely reset these settings to factory defaults. This clears any settings that the user has made, and should be used only to restore the RPM4 to a known state. RPM4 goes through its power up sequence after any type of reset is executed.

---

 *RPM4 reset functions will change current settings to factory defaults. These may include settings vital to RPM4 operation and affecting the calibration of the quartz reference pressure transducers (Q-RPTs). Reset functions should only be used by qualified personnel with knowledge of reset consequences. Reset functions should never be used “experimentally”.*

---

#### ○ OPERATION

To access the RESET menu, press **[SPECIAL]**, **<9reset>**. The display is:

1sets 2units 3ATest
4cal 5all

RESET menu choices include:

- <1set>** to reset general system operating parameters (see Section 3.5.9.1).
- <2units>** to reset unit of measure functions (see Section 3.5.9.2).
- <3ATest>** to reset AutoTest parameters, clear File AutoTest files and clear the AutoTest data log (see Section 3.5.9.3).
- <4cal>** to reset internal calibration coefficients and modes (see Section 3.5.9.4).
- <5all>** to reset all settings except ID and security password to factory default values (see Section 3.5.9.5).

#### 3.5.9.1 <1SETS>

##### ○ PURPOSE

Sets most general operating parameters back to default values. Does not affect calibration coefficients, remote interfaces or AutoRange ranges. The Reset – Sets resets are itemized in Table 9.

Table 9. Reset – Sets

RESET	RESULT	SEE SECTION
[UNIT]	Pressure unit of measure to first of the six available (psi)	3.3.2
[MODE]	Measurement mode to the native mode of the Q-RPT (absolute)	3.3.3
[RANGE]	Hi Q-RPT default range (10000 psi)	3.3.1
[HEAD]	0 cm height and Nitrogen medium	3.3.7
Stability Limit	0.005 % of Hi Q-RPT default range	3.4.3
Upper Limit	Hi Q-RPT default range default value	3.4.4
Resolution	0.001 % FS of Hi Q-RPT default range	3.4.2
AutoZ	AutoZ ON for both Q-RPTs and gauge and absolute measurement modes. $Z_{offset}$ value not affected	3.5.1
AutoZ	$P_{atm,0}$ set to 101.325 kPa a	3.5.1, 3.2.2
Leak Check	15 second run time. Clear logged results	3.3.5
Screen Saver	10 minutes to activation	3.5.5.1
Key Sounds	Medium tone valid key press sound	3.5.5.2
Lo Vnt	Automatic	3.5.7.4
ReadRate	Automatic	3.5.7.2

### 3.5.9.2 <2 UNITS>

#### ○ PURPOSE

Sets the pressure units available under the UNIT function to default selections depending (see Section 3.3.2).

Sets the user defined unit to 1.000/Pa (see Section 3.5.6).

Sets the reference temperature for inWa unit to 20°C.

### 3.5.9.3 <3ATEST>

#### ○ PURPOSE

- Resets Auto Tests to default characteristics (see Section 3.3.10).
- Clears File AutoTest definition files (see Section 3.4.5.2).
- Clears AutoTest results data logs (see Section 3.4.5.1).



## 3.5.9.4 &lt;4 CAL&gt;

## ○ PURPOSE

 The *Reset - Cal* function will reset the Q-RPT and barometer calibration coefficients and reset AutoZ values to zero. This will change the RPM4 calibration and could cause it to make out of tolerance measurements.

Clears all user values affecting the calibration of Q-RPTs and the on-board barometer. The Reset – Cal resets are itemized in Table 10.

Table 10. Reset – Cal

RESET	RESULT	SEE SECTION
All Q-RPT calibration coefficients	PA to zero, PM to 1	5.3.1
Q-RPT absolute mode	ON	5.3.5
On-board barometer calibration coefficients	PA to zero, PM to 1	5.2.2
Calibration date	Set all dates to 19800101	5.3.7
AutoZ values	All P <sub>offset</sub> values to zero for absolute mode and 101325 Pa for gauge and negative gauge modes	3.5.1
AutoZ function	ON, all Q-RPT s, all measurement modes	3.5.1

## 3.5.9.5 &lt;5 ALL&gt;

## ○ PURPOSE

 The *reset - all* function clears and deletes large amounts of user defined information including critical calibration data.

Combines all resets in one global reset command that clears the entire user section of non-volatile memory except the ID function (see Section 3.5.5.4) and the security level password (see Section 3.5.5.5) returning RPM4 to the “as delivered” condition. The Reset – All resets are itemized in Table 11.

Table 11. Reset – All

RESET	RESULT	SEE SECTION
Reset – Sets	All the resets of Reset - Sets	3.5.9.1
Reset – Units	All the resets of Reset - Units	3.5.9.2
Reset – Atest	All the resets of Reset - ATest	3.5.9.3
Reset – Cal	All the resets of Reset - Cal	3.5.9.4
Remote Interfaces	COM1, COM2 and IEEE-R88 interfaces to default settings.	3.5.2
Remote Communications	Remote command format to Classic	3.5.2.3
Level (Security)	Reset security level to low	3.5.5.5
Parallel Measurement Mode	Off	3.5.7.3

## NOTES



## 4. REMOTE OPERATION

### 4.1 OVERVIEW

Most of the RPM4 front panel functions can also be executed by commands from a remote computer. The host computer can communicate to the RPM4 using the RPM4's COM1 RS232 port or it's IEEE-488 port.

Before writing code using RPM4 remote commands, familiarize yourself with its operating principles by reviewing Section 3 of this manual.

### 4.2 INTERFACING

Sending a program message to the RPM4 places it into **remote** mode. The remote indicator to the right of the display window lights when the RPM4 is in **remote** mode. It also flickers when a program message is received. The menus usually accessed from the front panel are locked out while in remote. The [ESC] key returns the RPM4 to local operation unless the <REMOTE> program message, which locks out all keypad operation, was sent to the unit.

#### 4.2.1 RS232 INTERFACE

##### 4.2.1.1 COM1

The RPM4 COM1 RS232 interface is located on the back of the unit. It is a 9-pin male DB-9F connector configured as a DCE device. Data is transmitted out of the unit using pin 2, and is received on pin 3. This allows a normal pin-to-pin DB-9M to DB-9F RS232 cable to be used to connect to a DTE host.

Handshaking is not required or supported. The COM1 receive buffer is 80 bytes deep. If you overflow the buffer by sending too much data, the data will be lost. Because of this, you **must** send a single program message at a time and you **must** wait for the RPM4 to reply from the previous command before issuing another command.

**Table 12.** COM1 pin designations and connections

RPM4 COM1 DB-9F PIN DESIGNATIONS		
PIN #	FUNCTION	DESCRIPTION
2	TxD	This pin transmits serial data from the RPM4 to the host.
3	RxD	This pin accepts serial data from the host computer.
5	Grn	This pin is the common return for the TxD and RxD signals.

IBM PC/XT DB-9F CONNECTIONS		IBM PC/XT DB-9M TO RPM4 DB9F CONNECTION	
DB-25M	DB-9F	DB-9M	DB-9F
2	3	3	3
3	2	2	2
7	5	5	5

### 4.2.1.2 IEEE-488

The RPM4 IEEE-488 interface is located on the back of the unit. The physical and electrical interface conforms to IEEE Std 488.1-1987 Subset E2 and IEEE Std. 488.2-1992. You should not attempt to communicate with the IEEE-488 interface while using the COM1 interface. The IEEE-488 receive buffer is 250 bytes deep. If you attempt to overflow the buffer, the RPM4 will hold off release of the NFRD handshake line until it can service and empty the receive buffer. This keeps the buffer from overflowing. It is recommended that you check for errors using the “ERR?” query after sending a group of non-query program messages. When using queries, ensure that you wait for a reply to each query to ensue proper operation and order of command execution. Replies to queries remain in the reply queue until the host gets them, so they can “stack up”, causing replies to appear out of sequence.

### 4.2.1.3 COM2

The RPM4 COM2 RS232 interface is located on the back of the unit. It can be used to allow the host computer to communicate with another device through the RPM4. This allows the user to use one host COM port to communicate with the RPM4 and an additional RS232 device. Refer to the “#” remote program command for details.

COM2 is a 9-pin female DB-9F connector configured as a DTE device. Data is transmitted out of the RPM4 using pin 3, and is received on pin 2. This allows a normal pin-to-pin DB-9M to DB-9F RS232 cable to be used to connect to a DCE device.

Handshaking is not required or supported.

**Table 13.** COM2 DB-9F pin designations

PIN #	FUNCTION	DESCRIPTION
2	RxD	This pin transmits serial data from the RPM4 to a device.
3	TxD	This pin accepts serial data from the external device.
4	DTR	This pin is Data Terminal Ready (DTR) (held at + 5 V).
5	Grn	This pin is the common return for the TxD and RxD signals.

## 4.3 PROGRAMMING FORMATS

RPM4 supports two program message formats, the “**classic**”, and the “**enhanced**” formats. The user must select which format to use. Selection can be accomplished from the front panel (see Section 3.5.2.3) or remotely using the “**L2**” or “**L3**” program message (see Section 4.4.4). The “**MSGFMT**” command can also be used to select the format, but is not recommended for new designs.

The main difference between the “classic” and “enhanced” formats is that when using the IEEE-488 interface, a query operator “?” must be included in an enhanced command to yield a reply from the RPM4. When using the COM1 port in classic or enhanced mode or using the IEEE-488 port in classic mode, every command has a reply which the host must wait for before continuing. In addition, the enhanced message format supports IEEE Std 488.2 syntax, format and status reporting. The default is the classic format.

In either format, it is recommended that you start out a command sequence with the “\***CLS**” command, which clears all of the communication and error queues. The basic commands are similar for both the classic and enhanced formats, but the usage, syntax, format and status reporting are different.

Many RPM4 classic and enhanced commands are common with **DHI** PPC2+, PPCK+ and PPC3 Pressure/Controller Calibrators.

### 4.3.1 CLASSIC PROGRAM MESSAGE FORMAT

Each program message sent is also a query. You can only send one program message to the RPM4 at time. After sending any program message, you must wait for the RPM4 to reply before sending another program message. This reply will contain data, or a numeric error message if the program message was invalid. You must wait for this reply before issuing another program message to the RPM4. This insures that the RPM4 has completed the program message. Most remote program messages will return a reply within 500 ms except:

“PR?”, “PRR?”, “SR?”, “ATM?”, “RATE?”: Up to 2 seconds.

“RPT”, “ARANGE”, “AUTOZERO=RUN”: Up to 3 seconds

The syntax and format used for each program message in the classic mode is listed next to the keyword “Classic” in each program message summary in Section 4.4.4.

### 4.3.2 ENHANCED PROGRAM MESSAGE FORMAT

The enhanced program message format uses the IEEE Std. 488.2 format, syntax and status reporting. Errors are reported using the IEEE Std. 488.2 status reporting model. If an error is reported, the error is put into an Error Queue and the “ERR?” query program message can be used to get a text description of the most recent error. If you are using the IEEE-488 port, the service request line can be setup to be asserted if this occurs (see Section 4.5.2). In the enhanced format, there are two possible program message types for every program message. Each of these two types starts with the same basic text referred to as the program message header. The two types are COMMAND type and QUERY type commands.

#### 4.3.2.1 USING COMMAND TYPE COMMANDS



*Enhanced format commands DO NOT reply when using the IEEE-488 interface unless a “?” is included in the command. Do not expect a response from the RPM4’s IEEE-488 interface to non-query (no “?”) commands as there is none. Remote software will time-out waiting for a response from RPM4. However, in RS232 communications, there is always a response and the response MUST be read prior to issuing another command.*

The COMMAND type of program message executes a process and can additionally send data to the RPM4 in the form of comma delimited arguments. This data is usually a setting of some sort that is stored in the RPM4. If data is specified, it must be preceded by at least one white space from the program message header and be within the range and format described in the program message description. The keyword “**Command:**” appears to the left of the required syntax in each program message description in Section 4.4.4.

If you are using the IEEE-488 port, the Command type does not generate a reply unless you place a query operator “?” immediately after the command. You also may send multiple program messages at once by separating each program message with a semicolon. The commands are queued and executed in as received order after the entire message stream has been received, so care in determining order of execution is needed.

If you are using the RS232 port COM1, the Command type will always generate a reply so you **must** wait for a reply before issuing another program message. Because of this, you can only send one Command program message at a time while using the COM1 port.

**Examples:****• IEEE-488 enhanced mode command series using query operator:**

**\*\*CLS?** (Clear the error queue. Wait for reply)

**"UNIT? KPA"** (Generates a reply. User must wait for reply before continuing)

**"MMODE? A"** (Generates a reply. User must wait for reply before continuing)

**"PR?"** (Generates a reply. User must wait for reply before continuing)

**• IEEE-488 enhanced mode commands without query operator:**

**\*\*CLS** (Clear the error queue. No reply)

**"UNIT KPA"** (No reply)

**"MMODE A"** (No reply)

**"ERR?"** (Wait for reply. User should use **"ERR?"** query following a series of non query commands to check for errors that may have occurred)

**• IEEE-488 enhanced mode multiple commands without query operator:**

**\*\*CLS** (Clear the error queue. No reply)

**"UNIT KPA;MMODE A"** (Two command at once. No reply)

**"ERR?"** (Wait for reply. User should use **"ERR?"** query following a series of non query commands to check for errors that may have occurred)

**• COM1 enhanced mode command:**

**\*\*CLS** or **\*\*CLS?** (Clear the error queue. Wait for reply)

**"UNIT KPA"** or **"UNIT? KPA"** (Generates a reply. User must wait for reply before continuing)

**"MMODE A"** or **"MMODE? A"** (Generates a reply. User must wait for reply before continuing)

**"PR"** or **"PR?"** (Generates a reply. User must wait for reply before continuing)

#### 4.3.2.2 USING QUERY TYPE COMMANDS

The QUERY type of program message just requests data from the RPM4. Placing the query operator "?" immediately after the command creates a query. You **must** wait for a reply with a query. If you send any type of program message to the RPM4 after a query before receiving a reply, the program message is discarded and an error is generated. Errors are reported using the IEEE Std. 488.2 status reporting model. A Query program message always ends with a question mark. Most queries return a reply within 200 ms except:

**"PR?", "PRR?", "SR?", "ATM?", "RATE?":** Up to 2 seconds.

**"RPT", "ARANGE", "AUTOZERO RUN":** Up to 3 seconds

The syntax for using a QUERY program message is listed next to the keyword **"Query:"** in each program message summary in Section 4.4.4. Please note that queries in enhanced mode via the IEEE-488 port that results in an error will not result in a reply. You must check the error queue (use the "ERR" query) to see if an error has occurred.

## 4.4 COMMANDS

### 4.4.1 PROGRAMMING MESSAGES

Some commands accept an optional suffix. This suffix can be used to specify the explicit Q-RPT to address. In most cases, each Q-RPT in the RPM4 operates as an independent measurement device. If the suffix is not specified, then the “Active” Q-RPT is assumed. The “RANGE” or “ARANGE” command can be used to select the “Active” Q-RPT. See the program message descriptions for suffix use with a specific command.

**Table 14.** Program message list

COMMAND 'n' indicates an optional suffix	DESCRIPTION
#	Send a command string out of the RPM4 COM2 port.
ABORT	Stop pending operations
ARANGE <i>n</i>	Read or set a new AutoRange to use.
ATM	Read the current atmospheric pressure (on-board barometer).
AUTOZER <i>n</i>	Read or set the status of the AutoZ automatic zeroing function.
AUTOZER <i>n</i> =RUN	Run AutoZero.
CALAMB	Read or set the on-board barometer calibration
COM1	Read or set the configuration of the COM1 port.
COM2	Read or set the configuration of the COM2 port.
CONT <i>n</i>	Enable continuous measurements
DATE	Read or set the current date.
ERR	Read the last error message.
GPIB	Read or set the GPIB interface address.
HEAD	Read or set the fluid head settings.
ID	Read or set the RPM4 alphanumeric asset ID tag.
L2	Selects “classic” program message format
L3	Selects “enhanced” program message format
LOCAL	Return control to the RPM4 front panel.
MEM	Read the power-up memory test status.
MMODE <i>n</i>	Read or change the active measurement mode.
MSGFMT	Read or set the type of program message format to use.
PCAL <i>n</i>	Read or set the user Lo Q-RPT calibration information.
PCAL:XX	Read or set the user Lo Q-RPT calibration information (old command).
PR <i>n</i>	Read the next RPM4 pressure.
PRR <i>n</i>	Read the next RPM4 pressure, rate, and ATM.
QPRR <i>n</i>	Read the last RPM4 pressure, rate and ATM.
RANGE	Select a Q-RPT to be “active” in it’s default full scale range
RATE <i>n</i>	Read the next available rate of change of pressure.
READRATE <i>n</i>	Read or set the Q-RPT measurement read rate and mode
READYCK <i>n</i>	Read or set a flag that is cleared by a <i>Not Ready</i> condition.
REMOTE	Enable remote local lockout operation.
RES <i>n</i>	Read or set the pressure display resolution for the current transducer and range.
RESET	Reset the RPM4 to default user parameters.
RPT <i>n</i>	Read the available Q-RPT data.
SCRSAV	Read or set the front panel screen saver period.
SN	Read the serial number of the RPM4.
SR <i>n</i>	Read the next available pressure status ( <i>Ready/Not Ready</i> ).
SS <i>n</i>	Read or set the stability required for a <i>Ready</i> condition.
SS% <i>n</i>	Read or set the stability required for a <i>Ready</i> condition (% span/ s).
TIME	Read or set the current time of day.
UCOEF <i>n</i>	Convert a pressure in Pascal to pressure in the current units.
UDU	Read or set the user defined pressure unit.
UL <i>n</i>	Read or set the upper limit for the current range.
UNIT <i>n</i>	Read or set the pressure unit of measure for the current range.
VER	Read the RPM4 software version.
ZOFFSET <i>n</i>	Read or set the AutoZero $Z_{offset}$ for the specified Q-RPT.
ZOFFSET:XX	Read or set the AutoZ $Z_{offset}$ for the specified Q-RPT (old command).

## 4.4.2 ERROR MESSAGES

**Table 15.** Error #s and descriptions

REPLY	DESCRIPTION
ERR# 0	"OK"
ERR# 2	"Text argument is too long"
ERR# 3	"Arguments cannot be 0"
ERR# 4	"External device not detected"
ERR# 5	Not used
ERR# 6	"Numeric argument missing or out of range"
ERR# 7	"Missing or improper command argument(s)"
ERR# 8	"External device time-out error"
ERR# 9	"Unknown command"
ERR# 10	"Missing or invalid command suffix"
ERR# 11	"Command missing argument"
ERR# 12	"System overpressured" or "overpressure may result"
ERR# 13	"Text queue overflow"
ERR# 14	"User unit not defined"
ERR# 17	Not used
ERR# 18	"Command not yet available"
ERR# 19	"Not available with absolute units"
ERR# 20	"Not available with gauge device"
ERR# 21	Not used
ERR# 22	"Pressure is not stable"
ERR# 23	"Option not available or installed"
ERR# 25	Not used
ERR# 26	"COM port failed to initialize"
ERR# 27	"Internal device failure"
ERR# 28	"Device failure"
ERR# 29	"Device not available"
ERR# 30	"Must be on range HI"
ERR# 31	"Exceeds upper or lower limit"
ERR# 32	"Not stable enough"
ERR# 37	"Data table is full"
ERR# 38	"Selected range is not available"
ERR# 39	"Data verify error"
ERR# 45	"Argument not allowed"
ERR #46	"Argument cannot be negative"
ERR #52	"Command obsolete"
ERR# 53	"Not Available"



### 4.4.3 PROGRAM MESSAGE DESCRIPTION OVERVIEW

Each program message description is separated into the following sections:

Purpose	A brief description of the programs message's function.
Command	This is the Enhanced program message syntax to send data to the RPM4 or to execute an RPM4 function. The RPM4 <b>must</b> be set to use the enhanced format (see Section 3.5.2.3) to use the syntax and style shown. It may be sent alone, or followed by at least one white space and additional argument(s) to show that arguments can be passed. If there are multiple arguments, then commas must separate them. If you are using the IEEE-488 port, multiple command type program messages can be sent in one message if you separate them with a semicolon. There will be no reply from the RPM4 using the IEEE-488 port unless the command is immediately followed by the query operator "?". If you are using the COM1 port, the PPC1 will reply and you <b>must</b> wait for this reply. If this field is not listed in the program message description, then the Command type is not supported when using the Enhanced format.
Query	This is the Enhanced program message syntax to request data from the RPM4. The RPM4 <b>must</b> be set to use the enhanced format (see Section 3.5.2.3). The RPM4 will always reply to a query. You <b>must</b> wait for this reply before issuing another program message. If this field (Query) is not listed in the program message description, then the Query type for the program message is not supported when using the Enhanced format.
Classic	This is the Classic program message syntax to send data to the RPM4, to execute an RPM4 function, or to query for data. The RPM4 <b>must</b> be set to use the classic format (see Section 3.5.2.3). The command may be followed by a '(=)' and additional argument characters to show that argument(s) can be passed. If there are multiple arguments, then commas must separate them. The RPM4 will always reply to a Classic program message. You <b>must</b> wait for this reply before issuing another program message. If this field is not listed in the program message description, then it is not supported when using the classic format.
Suffix	Some commands support an optional suffix. This suffix is used to specify a Q-RPT to which the command applies, since many settings are Q-RPT specific: Suffix of '1' for Hi Q-RPT access Suffix of '2' for Lo Q-RPT access Suffix of '3' for HL Q-RPT access. If an optional suffix is allowed but not given, then the "Active Q-RPT" will be addressed. The "Active Q-RPT" is the Q-RPT that is currently displayed on the top line of the front panel of the RPM4, and is identified by the text label in the upper right of the pressure display screen. The last Q-RPT ranged or selected using the "RANGE" or "ARANGE" commands is the "Active" Q-RPT. The "ARANGE", "RANGE" or "RPT" command query can be used to determine which Q-RPT is currently active. With the Hi Q-RPT In differential mode of operation, there are some limitations on access to the Lo Q-RPT, and with the HL Q-RPT there are limitations on access to both the Hi and the Lo Q-RPTs independently.
Arguments	If the program message can be used to set data inside the RPM4, then this section describes the arguments and their limits.
Default	If the program message can be used to set data inside the RPM4, then this line shows (using the enhanced format) the default setting from the factory.
Remarks	This field has the details and remarks about the command.
Example	Examples are given for the enhanced and classic methods. <b>Enhanced:</b> An example of the use of an enhanced format program message to be sent to the RPM4 is shown. The message sent to the RPM4 appears after the "Cmd sent:" label. If only a Query type exists, the "Query sent:" label is shown instead. Directly under this label, "Query reply" shows a typical reply to a query type. "Reply:" shows that a query format does not exist. It may have a short description next to it. <b>Classic:</b> An example of the use of a classic program message to be sent to the RPM4 is shown. The command sent to the RPM4 appears after the "Cmd sent:" label. The "Reply" label shows a typical reply to the "Sent" example. It may have a short description next to it.
Errors	If the program message can report an argument error, the types of errors are listed. If using the classic format or the COM1 port, the error message is replied after receiving the program message. If using the enhanced format via the IEEE-488 port, the error condition is handled by the status reporting model which stores the errors in an Error Queue and can be programmed to assert the IEEE-488 SRQ line to signal an error has occurred. In either case, the "ERR" or "ERR?" program message can be used to retrieve a text description of the error.
See Also	Indicates related commands ("----") and refers to manual sections giving detail on RPM4 operation corresponding to the program message.

#### 4.4.4 PROGRAM MESSAGE DESCRIPTIONS

<b>#</b>	
Purpose	To allow the host PC to communicate with a device connected to the RPM4 COM2 port.
Classic	"#xx"
Arguments	xx: The string to send out of the RPM4 COM2 port. It must be less than 40 characters long.
Remarks	<p>The RPM4 COM2 port can be used to communicate to another RS232 device (such as another RPM4). This allows the user to use a single COM port or IEEE-488 port on the host computer to communicate with the RPM4 and another RS232 device. A carriage return and a line feed (&lt;CR&gt;&lt;LF&gt;) are added to the string.</p> <p>After this program message is issued, the RPM4 will reply back every string received by the RPM4 COM2 port that is terminated with a carriage return. Line feeds are discarded. This will discontinue when the next query is sent to the RPM4.</p> <p>There is no other reply from this program message. Prior to using this program message, you must ensure that the RPM4 COM2 port is correctly set up to communicate with the device on COM2. Refer to the "<b>COM2=</b>" program message.</p>
Example (classic)	<p>Sent: "#VER"</p> <p>Reply: "DH INSTRUMENTS, INC RPM4 us A1000/A0015 Ver2.00 "</p> <p>This example assumes that a second RPM4's COM1 port is connected to the RPM4 COM2 port. This example gets the version of the second RPM4.</p>
See Also	"COM2" 3.5.2

<b>ABORT</b>	
Purpose	Cancels any pending data requests by the "PR", "PRR" "RATE", "SR" or "CONT" commands.
Command Classic	"ABORT" "ABORT"
Remarks	This program message is usually used to ensure the RPM4 is in an idle condition.
Example (enhanced)	<p>Cmd sent: "ABORT"</p> <p>Reply: "ABORT" (no reply if IEEE-488)</p>
Example (classic)	<p>Sent: "ABORT"</p> <p>Reply: "ABORT"</p>
See Also	"PR", "PRR" "RATE", "SR" or "CONT"

<b>ARRANGE<math>n</math></b>	
Purpose	Read or set a new AutoRange range to use.
Command	"ARRANGE $n$ Range, unit, mode ( <i>RptLabel</i> )" (set to user defined range) "ARRANGE Q-RPTLabel" (set to Q-RPT default range)
Query	"ARRANGE?"
Classic	"ARRANGE= Range, units, mode ( <i>RptLabel</i> )" (set to user defined range) "ARRANGE= Q-RPTLabel" (set to Q-RPT default range)
Query	"ARRANGE"
Optional Suffix	" $n$ " A suffix may be used instead of " <i>RptLabel</i> " '1' Specify the Hi Q-RPT '2' Specify the Lo Q-RPT
Arguments	<i>Range</i> : The AutoRange maximum pressure. Cannot be negative. <i>Unit</i> : The unit of measure of the <i>Range</i> argument. <i>Mode</i> : The measurement mode of the <i>Range</i> argument: "A" for absolute "G" for gauge <i>RptLabel</i> : One of the Q-RPTs that is available. (optional) "IH": Hi Q-RPT "IL": Lo Q-RPT
Remarks	The ARRANGE command is used to define an RPM4 range by specifying a desired unit of measure, measurement mode and maximum pressure, and have the RPM4 pick the best available Q-RPT and make adjustments to optimize operation in that range.  The optional suffix or the " <i>RptLabel</i> " argument can be used to specify which Q-RPT you wish to use for the AutoRange range instead of allowing the RPM4 to pick the best Q-RPT. By using this option you can override the internal logic that picks the most suitable Q-RPT. This Q-RPT specified must be valid for the maximum pressure and measurement mode specified.  The reply indicates the current range data, including the Q-RPTLabel used for the range.  If "inWa" is specified for the unit, the temperature reference can be given after the unit text ("inWa4", "inWa20" or "inWa60" corresponding to inWa at 4 °C, 20 °C or 60 °F). If no number is given, a default of 20 °C is assumed. There is no indication of the temperature reference in the reply.  If you just specify the Q-RPTLabel without any other arguments, the Q-RPT specified will become active in it's last range and settings. The previously set unit and measurement mode for the Q-RPT specified will become active.
Example (enhanced)	Cmd sent: "ARRANGE?" (read the current range in the current units) Query reply: "100.00, psi, A, IH"
Example (classic)	Cmd sent: "ARRANGE" (read the current range in the current units) Query reply: "100.00, psi, A, IH"
Example (enhanced)	Cmd sent: "ARRANGE? 250, inWa4, G" (range of 250 inWa @ 4 °C in gauge mode) Query reply: "250.00 inWa, G, IH" (Lo Q-RPT is used)
Example (classic)	Cmd sent: "ARRANGE=500, kPa, G" (range of 500 kPa in gauge mode) Query reply: "500.00 kPa, G, IL" (Lo Q-RPT is used)
Example (enhanced)	Cmd sent: "ARRANGE2 50, psi, A" (range of 50 psi in absolute mode on the Lo Q-RPT) Query reply: "50.000 psi, A, IL" (No reply if GPIB-488)
Example (enhanced)	Cmd sent: "ARRANGE IH" (Hi Q-RPT's previous range made active) "500.000 kPa, A, IH" (No reply if GPIB-488) Query reply:
Errors	ERR# 6: " <i>Range</i> " maximum pressure exceeds available Q-RPTs or is negative. ERR# 10: RPT specified by the optional suffix is not valid for the current operating conditions ERR# 19: Cannot Range to '0' with absolute units. ERR# 20: Cannot Range to '0' with gauge units. ERR# 29: Correct type of Q-RPT for the selected " <i>Mode</i> " is not available. ERR# 53: RPT specified is not available.
See Also	"RPT", "RANGE", "MMODE", "UNIT" 3.3.4, .3.2.3, 3.3.3, 3.3.2

<b>ATM</b>	
Purpose	Reads the next measured pressure from RPM4's on-board barometer (if present).
Query	"ATM?"
Classic	"ATM"
Remarks	The atmospheric pressure as measured by the RPM4 on-board barometer is returned in the current pressure units of the active Q-RPT (always absolute). This measurement is followed by the units text. Not all RPM4s are equipped with an on-board barometer.
Example (enhanced)	Query sent: "ATM?" Query reply: "97.12348 kPa a"
Example (classic)	Sent: "ATM" Reply: "97.12384 kPa a"
Errors	ERR# 23: RPM4 is not equipped with a barometer.
See Also	3.5.7.1, 3.2.2

<b>AUTOZEROn</b>	
Purpose	Read or set the status of the AutoZ function.
Command	"AUTOZEROn <i>state</i> "
Query	"AUTOZEROn?"
Classic	"AUTOZEROn= <i>state</i> " "AUTOZEROn"
Default	"AUTOZERO1"
Optional Suffix	" <i>n</i> " The active Q-RPT is assumed if no suffix is given. '1' Specify the Hi Q-RPT '2' Specify the Lo Q-RPT
Arguments	' <i>state</i> ': '0' Autozero OFF '1' Autozero ON
Remarks	The RPM4 AutoZ function can be turned ON and OFF. There is a separate AutoZ flag for the gauge, absolute, and differential measurement modes for each Q-RPT. This command sets the AutoZ status for the current mode of the specified or the active Q-RPT only. To set the state of AutoZ for a measurement mode, you must be in that mode.
Example (enhanced)	Cmd sent: "AUTOZERO 0" Query reply: "0" (No reply if GPIB-488)
Example (classic)	Sent: "AUTOZERO=0" Query reply: "AUTOZERO=0"
Errors	ERR# 7: The argument was other than '0' or '1'. ERR# 10: The suffix is invalid.
See Also	"ZOFFSET", "MMODE" 3.5.1

<b>AUTOZEROn=RUN</b>	
Purpose	Run the AutoZero routine.
Command	"AUTOZEROn RUN ( <i>,Pref</i> )"
Query	"AUTOZEROn? RUN ( <i>,Pref</i> )"
Classic	"AUTOZEROn= RUN ( <i>,Pref</i> )"
Optional Suffix	" <i>n</i> " The active Q-RPT is assumed if no suffix is given. '1' Specify the Hi Q-RPT '2' Specify the Lo Q-RPT
Arguments	' <i>Pref</i> ': The AutoZ reference pressure in Pa. Optional when the RPM4 is not in absolute measurement mode, as the reference is usually "0".
Remarks	The RPM4 AutoZ function can be remotely run with this command only if AutoZero is ON. You should ensure that the pressure is stable for valid determination of $Z_{offset}$ .
Example (enhanced)	Cmd sent: "AUTOZERO RUN" Query reply: "OK" (No reply if GPIB-488)
Example (enhanced)	Cmd sent: "AUTOZERO? RUN, 97283" (abs AutoZero to 97283 Paa) Query reply: "OK"
Example (classic)	Sent: "AUTOZERO=RUN" Query reply: "OK"
Errors	ERR# 6: An argument was not given for the AutoZ reference in absolute mode. ERR# 10: Invalid suffix ERR# 53 AutoZero is currently OFF.
See Also	"ZOFFSET", "MMODE", "AUTOZERO" 3.3.9, 3.5.1

<b>CALAMB</b>	
Purpose	Read or set the on-board barometer calibration.
Command	"CALAMB <i>adder, mult, CalDate</i> "
Query	"CALAMB?"
Classic	"CALAMB= <i>adder, mult, CalDate</i> " "CALAMB"
Defaults	"CALAMB = 0.0, 1.0, 19800101"
Arguments	<i>Adder</i> : The Barometer calibration adder (PA), in Pascal. <i>Mult</i> : The Barometer calibration multiplier (PM) from 0.1 to 100. <i>CalDate</i> : The date of the calibration in the format "YYYYMMDD"
Remarks	The barometer calibration information can be accessed with this program message. Using this program message overwrites the current calibration coefficients, so caution must be used. Changes made take effect immediately.
Example (enhanced)	Cmd sent: "CALAMB? 2.1, 1.000021, 20011201" Query reply: " 2.10, 1.000021, 20011201"
Example (classic)	Sent: "CALAMB=2.1, 1.000021, 20011201" Reply: " 2.10, 1.000021, 20011201"
Errors	ERR# 6: One of the arguments is out of range.
See Also	3.5.7.1, 5.2.2

<b>COM1</b>	
Purpose	Read or set the RS232 settings for the COM1 port.
Command	"COM1 <i>baud, parity, data, stop</i> "
Query	"COM1?"
Classic	"COM1= <i>baud, parity, data, stop</i> " "COM1"
Arguments	<i>Baud:</i> The baud rate. This may be '300', '600', '1200', '2400', '4800', '9600' or '19200'. <i>Parity:</i> The data parity. This may be 'O' for odd, 'E' for even, or 'N' for none. <i>Data:</i> The number of data bits. This may be '7' or '8'. <i>Stop:</i> The number of stop bits. This may be '1' or '2'.
Defaults	"COM1 2400,E,7,1"
Remarks	The COM1 port is used to communicate to the RPM4. When the COM1 port configuration of the RPM4 is changed, the program message reply (COM1 use only) is sent at the old COM1 settings, but all subsequent communications are accomplished at the new COM1 settings. A 250ms or longer delay after receiving the reply to this command will ensure that the RPM4 has changed the COM port settings and is ready for communications at the new settings.
Example (enhanced)	Cmd sent: "COM1 9600,N,8,1" Query reply: "9600,N,8,1" (No reply if GPIB-488)
Example (enhanced)	Cmd sent: "COM1? 9600,N,8,1" Query reply: "9600,N,8,1"
Example (classic)	Sent: "COM1=9600,N,8,1" Reply: "9600,N,8,1"
Errors	ERR# 7: Missing or improper program message argument(s).
See Also	"COM2" 3.5.2.1

<b>COM2</b>	
Purpose	Read or set the RS232 settings for the COM2 port.
Command	"COM2 <i>baud,parity,data,stop</i> "
Query	"COM2?"
Classic	"COM2= <i>baud,parity,data,stop</i> " "COM2"
Arguments	<i>baud:</i> The baud rate. This may be '300', '600', '1200', '2400', '4800', '9600' or '19200'. <i>parity:</i> The data parity. This may be 'O' for odd, 'E' for even, or 'N' for none. <i>Data:</i> The number of data bits. This may be '7' or '8'. <i>stop:</i> The number of stop bits. This may be '1' or '2'.
Defaults	"COM2 2400,E,7,1"
Remarks	COM2 is generally used to allow the host computer to communicate through the RPM4 to an additional device connected to COM2. This can be useful if the host computer does not have 2 serial ports available.
Example (enhanced)	Cmd sent: "COM2 9600,N,8,1" Query reply: "9600,N,8,1" (No reply if GPIB-488)
Example (enhanced)	Cmd sent: "COM2? 9600,N,8,1" Query reply: "9600,N,8,1"
Example (classic)	Sent: "COM2=9600,N,8,1" Reply: "9600,N,8,1"
Errors	ERR# 7: Missing or improper program message argument(s).
See Also	"COM1" 3.5.2.1

<b>CONT<math>n</math></b>	
Purpose	Have the RPM4 reply continuously as each new measurement becomes available.
Query	"CONT $n$ ?"
Classic	"CONT $n$ "
Optional Suffix	" $n$ " The active Q-RPT is assumed if no suffix is given. '1' Specify the Hi Q-RPT '2' Specify the Lo Q-RPT
Remarks	This command is somewhat different from most as it enables the RPM4 to continuously output the selected Q-RPT's measurement without further queries. This continues until the next query is received by the RPM4, or if the ABORT" or "CLS" command is received. The frequency of the measurements is determined by the readrate of the Q-RPT. The data returned includes the pressure of the specified or active Q-RPT, current unit of measure and measurement mode.
Example (enhanced)	Query sent: "CONT1?" Query reply: "1936.72 kPa a" (repeats every measurement cycle)
Example (classic)	Query sent: "CONT" Reply: "1936.72 kPa a" (repeats every measurement cycle)
See Also	"PR", "READRATE", "ABORT"

<b>DATE</b>	
Purpose	Read or set the RPM4 date.
Command	"DATE <i>date</i> "
Query	"DATE?"
Classic	"DATE= <i>date</i> " "DATE"
Arguments	<i>date</i> : The date in the numerical only format "YYYYMMDD"
Remarks	The RPM4 has an internal real time calendar clock. The span of acceptable dates ranges from 19800101 to 20791231. The reply is always in the YYYYMMDD format.
Example (enhanced)	Cmd sent: "DATE 20030115" Query reply: "20030105" (No reply if GPIB-488)
Example (enhanced)	Cmd sent: "DATE? 20030105" Query reply: "20030105"
Example (classic)	Sent: "DATE=20021201" Reply: "20021201"
Errors	ERR# 6: Missing or improper program message argument(s).
See Also	"TIME" 3.5.5.3

<b>ERR</b>	
Purpose	Read the new available error message from the Error Queue.
Query	"ERR?"
Classic	"ERR"
Remarks	This program message obtains additional details about an error that has occurred. If the user receives an "ERR# $nn$ " reply, or the enhanced mode is enabled using the IEEE-488 interface and an error has been detected, the error is put into a FIFO Error Queue. The "ERR" program message pulls and replies the oldest error message available. In "classic" mode only the most recent error can reside in the queue. "OK" is replied if there are no error messages left. If an error occurs in enhanced mode using the IEEE-488 interface, no reply is generated even if the command was a query.
Example (enhanced):	Query sent: "ERR?" Query reply: "Numeric argument missing or out of range"
Example (classic)	Sent: "ERR" Reply: "Numeric argument missing or out of range"
See Also	4.4.2

<b>GPIB</b>	
<i>Purpose</i>	Read or set the GPIB interface address.
<i>Command</i>	"GPIB <i>addr</i> "
<i>Query</i>	"GPIB?"
<i>Classic</i>	"GPIB= <i>addr</i> " "GPIB"
<i>Defaults</i>	"GPIB 10"
<i>Arguments</i>	<i>Addr:</i> The address of the IEEE-488 (GPIB) interface (1 to 30)
<i>Remarks</i>	The GPIB address is changed following the reply of this command. Each device on a GPIB interface bus requires a unique address.
<i>Example (enhanced)</i>	Cmd sent: "GPIB 21" Query reply: "21" (No reply if GPIB-488)
<i>Example (enhanced)</i>	Cmd sent: "GPIB? 21" Query reply: "21"
<i>Example (classic)</i>	Sent: "GPIB=21" Reply: "21"
<i>Errors</i>	ERR# 6: The argument is not within given limits.
<i>See Also:</i>	3.5.2.2

<b>HEAD</b>	
<i>Purpose</i>	Read or set the fluid head settings.
<i>Command</i>	"HEAD <i>height, units, fluid</i> "
<i>Query</i>	"HEAD?"
<i>Classic</i>	"HEAD= <i>height, units, fluid</i> " "HEAD"
<i>Defaults</i>	"HEAD 0, cm, N2"
<i>Arguments</i>	<i>height:</i> The height of the test in relation to the RPM4. The value is positive if the test is above the RPM4, or negative if below the RPM4. The value can be between -9999 and 9999. Setting the value to '0' disables the head correction. <i>units:</i> The height units. This must be "in" or "cm". <i>gas:</i> The fluid type. This must be "N2", "Air", "He", "Oil", "H2O", or "User".
<i>Remarks</i>	The RPM4 can make a fluid head correction to allow it to display the pressure at a level other than the reference level of the RPM4.
<i>Example (enhanced)</i>	Cmd sent: "HEAD? 10,in,N2" Query reply: "10, in, N2"
<i>Example (classic)</i>	Sent: "HEAD=10,in,N2" Reply: "10, in, N2"
<i>Errors</i>	ERR# 2: The fluid text is too long ERR# 6: The height is not within given limits or the unit is invalid. ERR #7: The fluid text is invalid
<i>See Also:</i>	3.3.7, 3.5.3

<b>ID</b>	
<i>Purpose</i>	Read or set the user defined instrument identification label.
<i>Command</i>	"ID <i>string</i> "
<i>Query</i>	"ID"
<i>Classic</i>	"ID= <i>string</i> " "ID"
<i>Arguments</i>	<i>String:</i> An alphanumeric string up to 12 characters long.
<i>Remarks</i>	The user defined ID label can be used to allow the user to "tag" the RPM4 with a unique identifier. This ID is stored in non-volatile memory and cannot be erased by a power failure, system fault or reset. The ID should not be changed frequently, as the non-volatile memory may fail after 100,000 write operations.
<i>Example (enhanced)</i>	Cmd sent: "ID RPM4 #A01" Query reply: "RPM4 #A01" (No reply if GPIB-488)
<i>Example (enhanced)</i>	Cmd sent: "ID? RPM4 #A01" Query reply: "RPM4 #A01"
<i>Example (classic)</i>	Sent: "ID=RPM4 #A01" Reply: "RPM4 #A01"
<i>Errors</i>	ERR# 6 The ' <i>string</i> ' argument was longer than 12 char.
<i>See Also</i>	3.5.5.4

<b>L2 / L3</b>	
Purpose	Read or set the type of program command format to use (classic or enhanced).
Command	"L2" enables "classic" mode "L3" enables "enhanced" mode
Defaults	"L2" (Classic mode)
Remarks	The user can select the type of remote command format using these simplified commands. There is no query format. This format must agree with the format sent to the RPM4. This command is a replacement for the "MSGFMT" command.
Example (enhanced)	Cmd sent: "L3" Query reply: "L3" (No reply if IEEE-488)
Example (classic)	Sent: "L2" Reply: "L2"
See Also	"MSGFMT" 4.3, 3.5.2.3

<b>LOCAL</b>	
Purpose	Returns control to the RPM4 front panel.
Command	"LOCAL"
Classic	"LOCAL"
Remark	The REMOTE program message can lock the front panel out completely. The user can return to local operation by sending the LOCAL program message, sending the IEEE-488 'GTL' command (if in enhanced format), or by cycling RPM4 power.
Example (enhanced)	Cmd sent: "LOCAL" Reply: "LOCAL" (no reply if IEEE-488)
Example (enhanced)	Cmd sent: "LOCAL?" Reply: "LOCAL"
Example (classic)	Sent: "LOCAL" Reply: "LOCAL"
See Also	"REMOTE"

<b>MEM</b>	
Purpose	Read the status from the power-up memory test.
Query	"MEM?"
Classic	"MEM"
Remarks	The RPM4 system memory stores the user settings (units, resolution) and retains them when the unit is OFF. On power-up, this memory is checked. If this memory is corrupted, all user settings are reset to default, and the MEM status is set to reflect this.
Example (enhanced)	Query sent: "MEM?" Reply: "0" RPM4 data corrupted and was set to factory defaults. "1" The memory was found to be OK on power-up.
Example (classic)	Sent: "MEM" Reply: "MEM=0" RPM4 data corrupted and was set to factory defaults. "MEM=1" The memory was found to be OK on power-up.
See Also	3.5.9, 3.5.7.5



<b>MMODE<math>n</math></b>	
Purpose	Read or change the active measurement mode.
Command Query	"MMODE $n$ mode" "MMODE $n$ ?"
Classic	"MMODE $n$ =mode" "MMODE $n$ "
Optional Suffix	" $n$ " The active Q-RPT is assumed if no suffix is given. '1' Specify the Hi Q-RPT '2' Specify the Lo Q-RPT
Arguments	Mode: "A" Absolute mode "G" Gauge mode   <u>Measured pressure values are returned with "g" to identify measurement mode for both gauge and negative gauge measurement modes. Differential mode restricts access to settings on the Lo Q-RPT.</u>
Remarks	The measurement mode can also be set using the "UNIT" command but the "UNIT" command does not distinguish between gauge and negative gauge in it's reply, while the "MMODE" does. Measurement mode is range specific.
Example (enhanced)	Cmd sent: "MMODE A" Query reply: "A" (No reply if IEEE-488)
Example (enhanced)	Cmd sent: "MMODE? A" Query reply: "A"
Example (enhanced)	Cmd sent: "MMODE=G" Query reply: "G"
Errors	ERR# 6: Invalid argument text. ERR# 7: Abs mode only with altitude units or gauge mode only with gauge Q-RPT. ERR#10: The suffix indicating the Q-RPT is invalid for the current conditions. ERR# 20: Absolute or negative gauge mode not available with gauge Q-RPT. Absolute Q-RPT with an absolute and negative gauge OFF calibration. The current range cannot support gauge mode. ERR# 53: Gauge mode range would be negative. Lo Q-RPT not suitable for differential mode.
See Also	"UNIT", "ARANGE" 3.3.3

<b>MSGFMT</b>	
Purpose	Read or set the type of program command format to use (enhanced or classic).
Command Query	"MSGFMT mode" "MSGFMT?"
Classic	"MSGFMT= mode" "MSGFMT"
Arguments	mode: '1' to use the enhanced command format. '0' to use the classic command format.
Defaults	"MSGFMT 0"
Remarks	The user can select the type of remote command format to use. This format must agree with the format sent to the RPM4 The enhanced query form of this command ("MSGFMT? $n$ ") should always be used to set the desired format, as it will be accepted regardless of the current format (classic or enhanced). It is recommended to use the "L2" and "L3" commands instead of this command for new designs.
Example (enhanced)	Cmd sent: "MSGFMT 1" Query reply: "1" (No reply if IEEE-488)
Example (enhanced)	Cmd sent: "MSGFMT? 1" Query reply: "1"
Example (classic)	Sent: "MSGFMT=1" Reply: "MSGFMT=1"
Errors	ERR# 6: Missing or improper program message argument(s).
See Also	"L2 / L3" 4.3, 3.5.2.3

<b>PCAL<math>n</math></b>	
Purpose	Read or set the calibration information for the Hi or Lo Q-RPT.
Command Query	"PCAL $n$ <i>adder, mult, CalDate</i> " "PCAL $n$ ?"
Classic	"PCAL $n$ = <i>adder, mult, CalDate</i> " "PCAL $n$ "
Defaults	"PCAL $n$ = 0.0, 1.0, 19800101"
Optional Suffix	" $n$ " The active Q-RPT is assumed if no suffix is given. The Hi Q-RPT is assumed if the HL Q-RPT is active and no suffix is given. '1' Specify the Hi Q-RPT '2' Specify the Lo Q-RPT
Arguments	<i>Adder</i> : The Q-RPT calibration adder (PA). In Pascal. <i>Mult</i> : The Q-RPT calibration multiplier (PM) from 0.1 to 100. <i>CalDate</i> : The date of the calibration in the format "YYYYMMDD" by default. Any other format up to 8 characters long is also accepted, and the replied format is in the previously entered format.
Remarks	The user defined pressure calibration information for the specified Q-RPT (Hi or Lo) can be accessed with this program message. The HL Q-RPT does not have its own calibration information. Using this program message overwrites the current calibration coefficients, so caution must be used. Changes made using this program message take effect immediately. For compatibility with the obsolete style PPC3 "PCAL:HI" and "PCAL:LO" commands, ":HI" and ":LO" can be used in place of the suffix " $n$ " but this is not recommended for new applications.
Example (enhanced)	Cmd sent: "PCAL2? 2.1, 1.000021, 20011201" Query reply: " 2.10 Pa, 1.000021, 20011201" (No reply if GPIB-488)
Example (enhanced)	Cmd sent: "PCAL? 2.1, 1.000021, 20011201" Query reply: " 2.10 Pa, 1.000021, 20011201"
Example (enhanced)	Cmd sent: "PCAL:HI? 2.1, 1.000021, 20011201" (PPC3 style is OK) Query reply: " 2.10 Pa, 1.000021, 20011201"
Example (classic)	Sent: "PCAL1=2.1, 1.000021, 20011201" Reply: " 2.10 Pa, 1.000021, 20011201"
Errors	ERR# 6: One of the arguments is out of range. ERR# 10: The suffix is invalid.
See Also	5.3

<b>PR<math>n</math></b>	
Purpose	Read the next available pressure measurement.
Query	"PR $n$ ?"
Classic	"PR $n$ "
Optional Suffix	" $n$ " The active Q-RPT is assumed if no suffix is given. '1' Specify the Hi Q-RPT '2' Specify the Lo Q-RPT
Remarks	The next available pressure value for the specified or active Q-RPT is read in the current pressure units. The data returned also contains <i>Ready/Not Ready</i> information, and the pressure unit of measure and measurement mode. The reply field is always 20 characters long. The first 3 characters of the reply are reserved for the ready status. The ready status is described in the "SR" program message. The pressure value and pressure unit of measure are right justified in this field. After receiving this program message, the RPM4 replies back with the data after a new pressure measurement cycle is complete. This can take up to the current read rate period (1.2 seconds by default).
Example (enhanced)	Query sent: "PR?" Query reply: "R 1936.72 kPa a"
Example (classic)	Query sent: "PR" Reply: "R 1936.72 kPa a"
See Also	"PRR", "QPRR", "SR", "ABORT", "READRATE", "CONT" 3.1.1, 3.2.1, 3.5.7.2

<b>PRR</b>	
Purpose	Read the next available <i>Ready</i> condition, pressure measurement, rate and on-board barometer reading.
Query	"PRR?"
Classic	"PRR"
Optional Suffix	"n" The active Q-RPT is assumed if no suffix is given. '1' Specify the Hi Q-RPT '2' Specify the Lo Q-RPT
Remarks	The next available <i>Ready</i> condition, Q-RPT pressure measurement, rate of pressure change, and barometric pressure is replied in the current pressure unit of measure. . This can take up to the current read rate period (1.2 seconds by default). Each data field is separated by a comma, and is returned in the following order: ready, pressure UNITS, rate UNITS/s, atm UNITS Here are the field descriptions: ready: Three character ready status field. Refer to the "SR" command. pressure: The measured pressure for the active Q-RPT in the current pressure unit. This is followed by the current pressure unit. rate: The measured rate of pressure change for the active Q-RPT in the current pressure unit per second. This is followed by the current pressure unit of measure. atm: The pressure measured by the RPM4 on-board barometer in the current pressure unit (and always absolute). This is followed by the current pressure unit. Not all RPM4s are equipped with an on-board barometer. This field is missing if the RPM4 is not equipped with an on-board barometer.
Example (enhanced)	Query sent: "PRR?" Query reply: "R,2306.265 kPaa,0.011 kPa/s,97.000 kPa a" "R,2306.265 kPaa,0.011 kPa/s" (no barometer)
Example (classic)	Query sent: "PRR" Reply: "R,2306.265 kPaa,0.011 kPa/s,97.000 kPa a"
See Also	"PR", "QPRR", "SR" 3.1.1, 3.2.1, 3.5.7.1

<b>QPRR</b>	
Purpose	Read the last Q-RPT pressure measurement, pressure rate and on-board barometer output immediately.
Query	"QPRR?"
Classic	"QPRR"
Optional Suffix	"n" The active Q-RPT is assumed if no suffix is given. '1' Specify the Hi Q-RPT '2' Specify the Lo Q-RPT
Remarks	The last measured <i>Ready/Not Ready</i> condition, active Q-RPT pressure measurement, rate of pressure change, and barometric pressure is replied in the current pressure unit of measure immediately. This program message is useful when a rapid response of measured pressure is needed. It does not result in quicker pressure measurements. Each data field is separated by a comma, and is returned in the following order: Ready, pressure UNITS, rate UNITS/s, atm UNITS Here are the field descriptions: ready: Three character ready status field. Refer to the "SR" command. pressure: The measured pressure for the selected Q-RPT in the current pressure unit. This is followed by the current pressure unit and measurement mode. rate: The measured rate of pressure change for the active Q-RPT in the current unit of pressure per second. This is followed by the current pressure unit. atm: The pressure measured by the RPM4 on-board barometer in the current pressure unit (but always absolute). This is followed by the current pressure unit. Not all RPM4s are equipped with an on-board barometer. This field is missing if the RPM4 is not equipped with a barometer.
Example (enhanced)	Query sent: "QPRR?" Query reply: "R,2306.265 kPa a,0.011 kPa/s,97.000 kPa a" "R,2306.265 kPa a,0.011 kPa/s" (no barometer)
Example (classic)	Query sent: "QPRR" Reply: "R,2306.265 kPa a,0.011 kPa/s,97.000 kPa a"
See Also	"PR", "PRR", "SR" 3.1.1, 3.2.1, 3.5.7.1

<b>RANGE</b>	
Purpose	Change the active range to the default range of the Hi or Lo. Replies the active range full scale, pressure unit and measurement mode.
Command Query	"RANGE <i>Rng</i> " "RANGE?"
Classic	"RANGE= <i>Rng</i> " "RANGE "
Default	"RANGE IH" <i>Rng</i> : "IH" for the Hi Q-RPT "IL" for the Lo Q-RPT
Remarks	The active Q-RPT must be selected before making changes to settings that are dependent on the range. Q-RPTs selected with this command are used with their full default pressure range. The reply indicates the active range in psi if the RPM4 is a "US" version or in kPa if the RPM4 is an "SI" version. Used as a simple query, the active range is returned, which can be an AutoRanged range or a default range (see "ARANGE" cmd).
Example (enhanced)	Cmd sent: "RANGE? IL" (select internal Lo Q-RPT in it's full default range) Query reply: "2.2 psi g,IL"
Example (classic)	Sent: "RANGE= IH" (select internal Hi Q-RPT in it's full default range) Reply: "1000 psi a, IH"
Example (classic)	Sent: "RANGE" (request current range) Reply: "220 psi a,IL"
Errors	ERR# 6: Invalid <i>Rng</i> argument. ERR# 29: The selected Q-RPT is not available.
See Also	"ARANGE", "RPT" 3.2.3, 3.3.1, 3.3.4

<b>RATE<math>n</math></b>	
Purpose	Read the next available pressure rate of change.
Query	"RATE $n$ ?"
Classic	"RATE $n$ "
Optional Suffix	" $n$ " The active Q-RPT is assumed if no suffix is given. '1' Specify the Hi Q-RPT '2' Specify the Lo Q-RPT
Remarks	The next available pressure rate of change in the current pressure unit per second is returned. After receiving this program message, the RPM4 replies back with the data once a new pressure measurement cycle is complete. This can take up to the current read rate period (1.2 seconds by default).
Example (enhanced)	Query sent: "RATE?" Query reply: "0.01 kPa/s"
Example (classic)	Sent: "RATE2" Reply: "0.03 kPa/s"
See Also	"PRR", "QPRR", "READRATE" 3.3.6.2

<b>READRATE<math>n</math></b>	
Purpose	Read or set the specified or active Q-RPT read rate or auto read rate mode.
Command Query	"READRATE $n$ <i>period</i> " "READRATE $n$ ?"
Classic	"READRATE $n$ = <i>period</i> " "READRATE $n$ "
Optional Suffix	" $n$ " The active Q-RPT is assumed if no suffix is given. '1' Specify the Hi Q-RPT '2' Specify the Lo Q-RPT
Arguments	" <i>period</i> ": Period to integrate the measurement over (ms). Can be from 200 ms to 20000 ms. Set to '0' to enable automatic read rate.
Remarks	The RPM4 can have the speed in which it integrates each measurement ("read rate") automatically adjusted based on the rate, or it can manually set to a fixed period. Increasing the read rate increases the reply time for pressure and rate queries. In differential mode and when using the HL Q-RPT, the Lo Q-RPT read rate is always set to the same read rate as the Hi.
Example (enhanced)	Cmd sent: "READRATE 1000" Query reply: "1000" (No reply if GPIB-488)
Example (enhanced)	Cmd sent: "READRATE? 1000" Query reply: "1000"
Example (classic)	Sent: "READRATE=1000" Reply: "1000"
Errors	ERR# 6: The " <i>period</i> " argument is out of range. ERR#10: The suffix ' $n$ ' is invalid
See Also	"PR", "PRR", "SR" 3.5.7.2

<b>READYCK<math>n</math></b>	
Purpose	Read or set the <i>Ready</i> check flag.
Command	"READYCK $n$ 1"
Query	"READYCK $n$ ?"
Classic	"READYCK $n$ =1" "READYCK $n$ "
Optional Suffix	" $n$ " The active Q-RPT is assumed if no suffix is given. '1' Specify the Hi Q-RPT '2' Specify the Lo Q-RPT
Remarks	The internal ready check flag is cleared whenever the specified or active Q-RPT reaches a <i>Not Ready</i> (NR) condition. The "READYCK" query returns the status of the flag. The flag is set by sending the "READYCK 1" program message while the Q-RPT is in a <i>Ready</i> condition. The "READYCK" program message query can then be used at a later time to determine whether a <i>Not Ready</i> condition has occurred since the ready check flag was set.
Example (enhanced)	Cmd sent: "READYCK1 1" Query reply: "1" (no reply if GPIB-488)
Example (enhanced)	Cmd sent: "READYCK1?" Query reply: "1"
Example (enhanced)	Cmd sent: "READYCK?" Query reply: "1" (if Q-RPT condition has stayed <i>Ready</i> ) "0" (if Q-RPT condition has NOT stayed <i>Ready</i> )
Example (classic)	Sent: "READYCK=1" Query reply: "READYCK=1"
Example (classic)	Sent: "READYCK" Query reply: "READYCK=1" (if Q-RPT condition has stayed <i>Ready</i> ) "READYCK=0" (if Q-RPT condition has NOT stayed <i>Ready</i> )
Errors	ERR# 6: Argument is not a '0' or a '1'.
See Also	"SR" 3.2.1

<b>REMOTE</b>	
Purpose	Lock out the front panel keypads during remote operation.
Command	"REMOTE"
Classic	"REMOTE"
Remarks	The RPM4 goes into remote mode whenever communications take place. The user can return to local operation by pressing the [ESC] key. The REMOTE program message locks out the front panel completely. The only way to unlock the front panel after the "REMOTE" command is using the "LOCAL" program message, the IEEE-488 "GTL" command, or by cycling the RPM4 power.
Example (enhanced)	Cmd sent: "REMOTE" Reply: "REMOTE" (no reply if IEEE-488)
Example (enhanced)	Cmd sent: "REMOTE?" Reply: "REMOTE"
Example (classic)	Sent: "REMOTE" Reply: "REMOTE"
See Also	"LOCAL"

<b>RES<math>n</math></b>	
Purpose	To read or set the pressure display resolution for the active range.
Command	"RES $n$ <i>res</i> "
Query	"RES $n$ "
Classic	"RES $n$ = <i>res</i> " "RES $n$ "
Default	"RES $n$ =0.001"
Optional Suffix	" $n$ " The active Q-RPT is assumed if no suffix is given. '1' Specify the Hi Q-RPT '2' Specify the Lo Q-RPT
Arguments	<i>res</i> : The pressure display resolution in % span of the specified Q-RPT range (0.0001 to 1 % FS).
Remarks	The pressure display resolution is defined as % span of the active range. The setting is separate for each range, and changes as the range is changed.
Example (enhanced)	Cmd sent: "RES .01" Query reply: "0.01" (No reply if GPIB-488)
Example (enhanced)	Cmd sent: "RES? .01" Query reply: "0.01"
Example (classic)	Sent: "RES=.01" Reply: "0.01"
Errors	ERR# 6 The argument is invalid.
See Also	3.4.2

<b>RESET</b>	
Purpose	Reset the user's settings to factory defaults. Corresponds to front panel "Reset – Sets".
Command	"RESET"
Classic	"RESET"
Remarks	The RPM4 has user settings (units, resolution, etc.) that can be reset to factory defaults. The remote "RESET" program message corresponds to the front panel "Reset - Sets". System calibration coefficients and communications settings are not affected. The reset cycle takes up to 3 seconds to complete. Remote communications should not take place during this period.
Example (enhanced)	Cmd sent: "RESET" Reply: "RESET" (no reply if IEEE-488)
Example (enhanced)	Cmd sent: "RESET?" Reply: "RESET"
Example (classic)	Sent: "RESET" Reply: "RESET"
See Also	3.5.9.1, 3.5.9

<b>RPTn</b>	
Purpose	Read the available Q-RPT identification data.
Query	"RPTn"
Classic	"RPTn"
Optional Suffix	"n" The active Q-RPT is assumed if no suffix is given. '1' Specify the Hi Q-RPT '2' Specify the Lo Q-RPT
Remarks	Up to two internal Q-RPTs can be available for use in an RPM4. You can query the RPM4 for information about each particular Q-RPT. The Q-RPT data is returned in the following format: <i>RPTLabel, Q-RPTLocator, Serial#, RngGa, RngAbs, Q-RPTMode</i> RngLabel: RPT type label. This label identifies the Q-RPT type and range. This is the same label used on the RPM4 front panel screen. RptLocator: Text field identifying the Q-RPT position in the RPM4 system. "IH" identifies this as an internal, Hi Q-RPT "IL" identifies this as an internal, Lo Q-RPT Serial#: The serial number of the Q-RPT. RngGa: The Q-RPT default gauge mode range in the current pressure unit. RngAbs: The Q-RPT default absolute mode range in the current pressure unit. "NONE" appears in the field if the Q-RPT is a Gxxx, BGxxx or Axxx with absolute and negative gauge modes OFF. RptMode: 'A' if Q-RPT is Axxx and supports absolute, gauge and negative gauge measurement modes. 'G' if Q-RPT is gauge Gxxx or Axxx with absolute and negative gauge modes OFF and supports only gauge measurement mode. 'N' if Q-RPT is BGxxx and supports gauge and negative gauge measurement modes.
Example (enhanced)	Cmd sent: "RPT2?" (Get information on the Lo Q-RPT) Query reply: "A350K, IL, 82345, 35, 50,A"
Example (classic)	Cmd sent: "RPT3" (Get information on the HL Q-RPT) Query reply: "A7M, HL, 82345, 1000, 1000,A"
Errors	ERR#4: External device not detected. ERR# 10: Invalid suffix.
See Also	3.2.3

<b>SCRSV</b>	
Purpose	Read or set the front panel display screen saver activation time.
Command	"SCRSV n"
Query	"SCRSV?"
Classic	"SCRSV=n" "SCRSV"
Arguments	n: The inactivity period (0 – 99 minutes) after which screen saver activates.
Default	"SCRSV 10"
Remarks	The RPM4 front panel will dim after a period of keyboard and remote inactivity. Setting this value to '0' disables this feature.
Example (enhanced)	Cmd sent: "SCRSV 30" Query reply: "30" (No reply if GPIB-488)
Example (enhanced)	Cmd sent: "SCRSV? 30" Query reply: "30"
Example (classic)	Sent: "SCRSV=30" Reply: "30"
Errors	ERR# 6 The argument was invalid.
See Also	3.5.5.1

<b>SN</b>	
Purpose	To read the serial number of the RPM4.
Query	"SN?"
Classic	"SN"
Remarks	The RPM4 is serialized. The serial number can be read using this program message.
Example (enhanced)	Query sent: "SN?" Query reply: "321"
Example (classic)	Sent: "SN" Reply: "321"
See Also	3.5.5.4

<b>SR</b>	
Purpose	Read the next available <i>Ready/Not Ready</i> status.
Query	"SR?"
Classic	"SR"
Optional Suffix	"n" The active Q-RPT is assumed if no suffix is given. '1' Specify the Hi Q-RPT '2' Specify the Lo Q-RPT
Remarks	The current <i>Ready</i> status can be read using this program message. Possible replies: "NR" The pressure is not ready within the limits defined by the stability criterion. "R " The pressure meets the ready criteria. The status is replied when the next pressure measurement is finished. "UL" The pressure of one of the active Q-RPTs has exceeded the user defined upper or lower limits. "OP" The pressure of one of the Q-RPTs has exceeded the Q-RPT's maximum limits. "ER" An internal device failure has occurred.
Example (enhanced)	Query sent: "SR?" Query reply: "NR"
Example (classic)	Sent: "SR" Reply: "NR"
See Also	"PR", "PRR", "HS", "SS", "UL", "LL" 3.2.1, 3.4.4, 3.4.4.1

<b>SS%n</b>	
Purpose	Read or set the current stability limit as a % of range.
Command	"SS% <i>limit</i> "
Query	"SS%?"
Classic	"SS%= <i>limit</i> " "SS%"
Optional Suffix	"n" The active Q-RPT is assumed if no suffix is given. '1' Specify the Hi Q-RPT '2' Specify the Lo Q-RPT
Arguments	<i>limit</i> : The stability limit in %FS of the current active range.
Remarks	The stability limit can be read and set as a percent of the full scale range of the Q-RPT range.
Example (enhanced)	Cmd sent: "SS% .1" Query reply: "0.10 %"(No reply from GPIB-488)
Example (enhanced)	Cmd sent: "SS%? .1" Query reply: "0.10 %"
Example (classic)	Sent: "SS%=.1" Reply: "0.10 %"
Errors	ERR# 6: The argument was invalid. ERR# 10: Invalid or missing command suffix.
See Also	"SS" 3.4.3

<b>SSn</b>	
Purpose	Read or set the current pressure stability limit.
Command	"SS <i>limit</i> "
Query	"SS?"
Classic	"SS= <i>limit</i> " "SS"
Optional Suffix	"n" The active Q-RPT is assumed if no suffix is given. '1' Specify the Hi Q-RPT '2' Specify the Lo Q-RPT
Arguments	<i>Limit</i> : The stability limit in the current pressure unit of measure.
Remarks	The stability limit can be read and set as a pressure. The stability limit is used as the <i>Ready/Not Ready</i> criteria..
Example (enhanced)	Cmd sent: "SS .1" Query reply: "0.10 kPa/s" (No reply from GPIB-488)
Example (enhanced)	Cmd sent: "SS? .1" Query reply: "0.10 kPa/s"
Example (classic)	Sent: "SS=.1" Reply: "0.10 kPa/s"
Errors	ERR# 6: The argument was invalid. ERR# 10: Invalid or missing command suffix.
See Also	"SS%" 3.4.3

<b>TIME</b>	
Purpose	Read or set the RPM4 internal clock.
Command	"TIME <i>hh:mmXX</i> "
Query	"TIME?"
Classic	"TIME= <i>hh:mmXX</i> " "TIME"
Arguments	<i>hh:mm</i> : The time in a 12 hour format using a colon delimiter <i>XX</i> : "am" or "pm"
Example (enhanced)	Cmd sent: "TIME 12:52PM" Query reply: "12:52pm" (No reply if GPIB-488)
Example (enhanced)	Cmd sent: "TIME? 12:52PM" Query reply: "12:52pm"
Example (classic)	Sent: "TIME=12:52PM" Reply: "12:52pm"
Errors	ERR# 7: Missing or improper program message argument(s).
See Also	"DATE" 3.5.5.3

<b>UCOEFn</b>	
Purpose	To identify the coefficient used to convert 1 Pascal to the current pressure unit of measure.
Query	"UCOEFn?"
Classic	"UCOEFn"
Optional Suffix	"n" The active Q-RPT is assumed if no suffix is given. '1' Specify the Hi Q-RPT '2' Specify the Lo Q-RPT
Remarks	The RPM4 handles all pressure values internally in Pascal. The coefficient replied is equivalent of 1 Pa in the current pressure unit of measure. This program message allows the user to convert pressures
Example (enhanced)	Query sent: "UCOEF?" Query reply: "0.0010000000"
Example (classic)	Sent: "UCOEF" Reply: "0.0010000000"
See Also	3.3.2, 3.5.6, 7.1.1



<b>UDU</b>	
Purpose	Read or set the user defined pressure unit.
Command Query	"UDU <i>label</i> , <i>ucoef</i> " "UDU?"
Classic	"UDU= <i>label</i> , <i>ucoef</i> " "UDU" <i>label</i> : User unit label (4 alphanumeric char maximum). It cannot be an already supported unit label. <i>Ucoef</i> : "User unit conversion coefficient (units/Pa).
Default	"UDU USER,1.0"
Remarks	The user defined unit must be set up with the program message prior to remote or local selection.
Example (enhanced)	Cmd Sent: "UDU MYUN, .001" Query reply: "MYUN, 0.001000" (No reply if GPIB-488)
Example (enhanced)	Cmd Sent: "UDU? MYUN, .001" Query reply: "MYUN, 0.001000"
Example (enhanced)	Sent: "UDU=MYUN, .001" Reply: "MYUN, 0.001000"
Errors	
See Also	3.5.6, 3.3.2

<b>Uln</b>	
Purpose	Read or set an upper limit for the specified or active Q-RPT.
Command Query	"Uln <i>limit</i> " "Uln?"
Classic	"Uln= <i>limit</i> " "ULn"
Optional Suffix	"n" The active Q-RPT is assumed if no suffix is given. '1' Specify the Hi Q-RPT '2' Specify the Lo Q-RPT
Arguments	" <i>limit</i> ": The upper limit pressure in the specified Q-RPT's current pressure unit and measurement mode. If the unit is meters, this value is be interpreted in kPa. If the unit is feet, this value is be interpreted in psi.
Remarks	The RPM4 has an upper limit for each range and for each measurement mode (gauge, absolute). If the pressure does exceed the upper limit, the pressure display flashes. This feature should always be used to prevent accidental over pressure of a device under test.
Example (enhanced)	Cmd sent: "UL 1000" Query reply: "1000.00 kPa a" (No reply if GPIB-488)
Example (enhanced)	Cmd sent: "UL? 1000" Query reply: "1000.00 kPa a"
Example (classic)	Sent: "UL=1000" Reply: "1000.00 kPa a"
Errors	ERR# 6: The " <i>limit</i> " argument is out of range.
See Also	3.4.4

<b>UNIT<math>n</math></b>	
Purpose	Read or set the pressure unit of measure unit and measurement mode.
Command	"UNIT $n$ unit ( <i>ref</i> )" "UNIT $n$ unitn ( <i>ref</i> )" "UNIT $n$ unitg ( <i>ref</i> )" "UNIT $n$ unita ( <i>ref</i> )" "UNIT $n$ unitd ( <i>ref</i> )" "UNIT $n$ ?"
Query	
Classic	"UNIT $n$ =unit ( <i>ref</i> )" "UNIT $n$ =unitn ( <i>ref</i> )" "UNIT $n$ =unitg ( <i>ref</i> )" "UNIT $n$ =unita ( <i>ref</i> )" "UNIT $n$ =unitd ( <i>ref</i> )" "UNIT $n$ "
Optional Suffix	" $n$ "      The active Q-RPT is assumed if no suffix is given. '1'    Specify the Hi Q-RPT '2'    Specify the Lo Q-RPT
Arguments	<i>Unit</i> :      The text corresponding to the pressure unit of measure. A unit mode character can optionally be added to the end of the units: <i>ref</i> :        'a' for absolute measurement mode. 'g' for gauge measurement mode. The optional unit reference temperature only if the unit is "InWa"
Remarks	This program message determines what unit of measure and what measurement mode is used to display pressure values. Refer to Table 7 for a detailed list of the units available and their labels. If the unit text is not followed by an explicit mode character ('a', 'g') then "gauge" mode is assumed. There can be a space between the unit text and the 'a' or 'g'. If the unit specified is "InWa", an optional second argument " <i>ref</i> " can be set. The " <i>ref</i> " can be 4, 20, or 60 corresponding to InWa at 4 °C, 20 °C or 60 °F. If this second argument is not given when the unit is "InWa", then the reference temperature is assumed to be 20 °C. This can also be added directly onto the end of the <i>Unit</i> argument if desired. The fifth character of the reply is always 'a' for absolute mode or 'g' for gauge/negative gauge mode. White spaces precede this character if needed. The temperature reference is added to the reply only if the unit is "InWa". The reply includes the measurement mode character in the fifth position, with an 'a' indicating absolute mode or a 'g' indicating gauge. The "MODE" command can also be used to set the desired measurement mode only.
Example (enhanced)	Cmd sent:    "UNIT? kPaa" Query reply: "kPaa" Sent:        "UNIT? InWag, 4" Query reply: "inWag, 4" Sent:        "UNIT? InWaa60" Query reply: "inWaa, 60"
Example (enhanced)	Cmd sent:    "UNIT psi n" Query reply: "psi g"            ('g' used to indicate both gauge & neg gauge modes)
Example (classic)	Sent:        "UNIT=kPaa" Reply:       "kPaa" Sent:        "UNIT=InWag, 4" Reply:       "inWag, 4"
Errors	ERR# 7:      The <i>unit</i> is invalid. ERR# 6:      The <i>ref</i> is invalid. ERR# 20:     Absolute measurement mode and altitude units are not allowed with a gauge Q-RPT.
See Also	"MMODE", "MODE" 3.3.2, 3.3.3, 3.5.6, 7.1.1
<b>VER</b>	
Purpose	Identify the RPM4, US or SI units, the Q-RPT labels and the software version.
Query	"VER?"
Classic	"VER"
Remarks	The software version of the RPM4 can be read. This is useful for checking for the presence of the RPM4 and for reference purposes. It indicates the internal Q-RPT(s) and software version.
Example (enhanced)	Query sent:    "VER?" Query reply:   "DH INSTRUMENTS, INC RPM4 us A350K/BG15K Ver1.00 "
Example (classic)	Query sent:    "VER?" Query reply:   "DH INSTRUMENTS, INC RPM4 us A350K/BG15K Ver1.00 "
See Also	"ID", "**IDN?" None

<b>ZOFFSET<math>n</math></b>	
Purpose	Read or set the AutoZ pressure offset ( $P_{offset}$ ) for the specified or active Q-RPT in the current measurement mode.
Command	"ZOFFSET $n$ <i>GaOffset</i> , <i>AbsOffset</i> , <i>DifOffset</i> "
Query	"ZOFFSET $n$ ?"
Classic	"ZOFFSET $n$ = <i>GaOffset</i> , <i>AbsOffset</i> , <i>DifOffset</i> " "ZOFFSET $n$ "
Defaults	"ZOFFSET $n$ = 0.0, 0.0, 0.0" (Gauge Q-RPT) "ZOFFSET $n$ = 101325, 0.0, 0.0" (Absolute Q-RPT)
Optional Suffix	" $n$ " The active Q-RPT is assumed if no suffix is given. '1' or ":HI" Specify the Hi Q-RPT '2' or ":LO" Specify the Lo Q-RPT
Arguments	<i>GaOffset</i> : The Q-RPT pressure offset ("Poffset") for Gauge measurement mode (Pa). <i>AbsOffset</i> : The Q-RPT pressure offset for absolute measurement mode (Pa)
Remarks	The pressure offset ( $P_{offset}$ ) for the specified Q-RPT (Hi or Lo) can be accessed with this program message. There are separate offsets for gauge and absolute modes. Using this program message overwrites the current offset, so caution must be used. Changes made using this program message take effect immediately.
Example (enhanced)	Cmd sent: "ZOFFSET1 2.1, 0, 0" Query reply: " 2.10 Pa, 0.00 Pa, 0.00 Pa"
Example (classic)	Sent: "ZOFFSET=97293.1, 3.02, 0" Reply: " 97293.10, 3.02, 0.00"
Errors	ERR# 6: One of the arguments is out of range.
See Also	3.5.1

## 4.5 STATUS REPORTING SYSTEM

The RPM4 status reporting system is used to track and report system status and errors. It follows the model of the IEEE Std 488.2 and works for the COM1 and the IEEE-488 port with slight differences. The RPM4 can be programmed to respond to various status conditions by asserting the SRQ of the IEEE-488 interface. The COM1 port cannot be supported in such a way, so polling must be used.

### 4.5.1 ERROR QUEUE

The RPM4 keeps track of remote errors by using an error queue. If an error occurs, it is pushed onto the Error Queue. If you are using the COM1 port, the error number is immediately replied in the form "ERR# $nn$  where  $nn$  is the error code from 0 to 99. The "ERR?" (or "ERR") query can then be used to pull the error from the Error Queue in its descriptive text format. If you are using the enhanced program message format, the Error Queue will accumulate errors until full unless they are pulled from the queue. If you are using the classic program format, the Error Queue is cleared every time a new program message is received.

## 4.5.2 STATUS BYTE REGISTER

The RPM4 contains an 8 bit Status Byte Register that reflects the general status of the RPM4.

**Table 16.** 8 Bit status byte register

<b>OPER</b> (128)	<b>RQS/MSS</b> (64)	<b>ESB</b> (32)	<b>MAV</b> (16)	<b>N/A</b> (8)	<b>ERROR</b> (4)	<b>N/A</b> (2)	<b>RSR</b> (1)
----------------------	------------------------	--------------------	--------------------	-------------------	---------------------	-------------------	-------------------

This register is affected by the RPM4 reply output queue, the Error Queue, the Standard Event Status register and the *Ready Event* Status register.

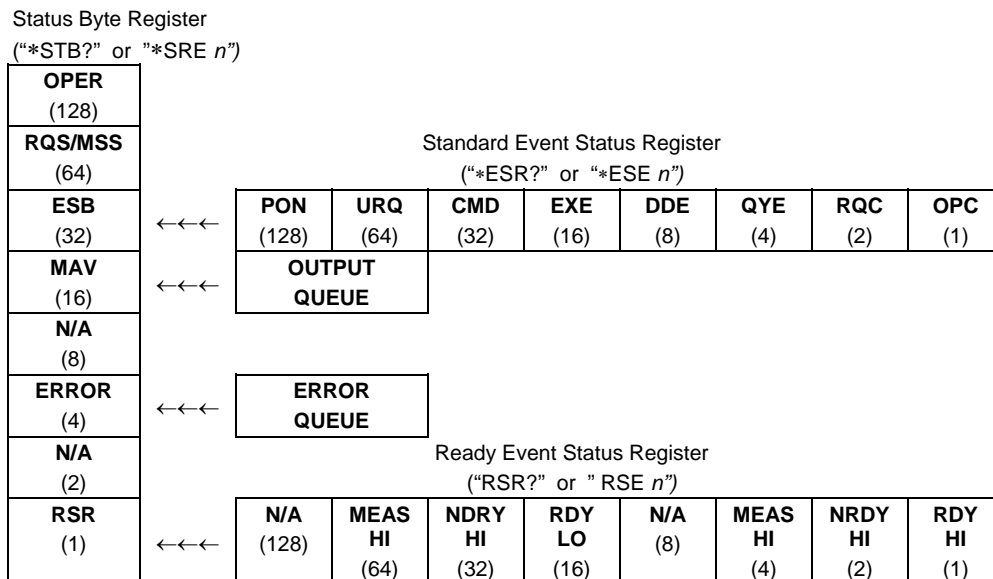

**Figure 11.** Status register schematic

The Status Byte Register can be read using the "**STB?**" query, or by performing a serial poll on the IEEE-488 bus. If you read this using a serial poll then Bit 6 is the RQS. If the "**STB?**" query is used, then bit 6 is the MSS bit. All of the other bits are common to both types of query.

Each of these status bits can cause a SRQ to occur. The Service Request Enable Register ("**SRE**" program message) determines which of these flags are able to assert the SRQ line. This enable register has a matching set of bits that each will enable the designated bit to cause a SRQ, except for the RQS/MSS bit(s) which cannot cause a SRQ. If you set this register to 20 (\$14 hex), an SRQ will occur if the MAV or the ERROR bit are set. The description of these bits are given as:

**OPER** N/A Bit 7 (128)

**RQS** Requested Service Bit 6 (64)

Indicates that the SRQ line of the IEEE-488 interface has been asserted by the RPM4. This bit is cleared when a serial poll is performed on the RPM4, and is a part of the Status Byte Register when read using a serial poll. This bit does not apply if the COM1 port is being used.

**MSS** Master Summary Status Bit 6 (64)

Indicates that an event or events occurred that caused the RPM4 to request service from the Host, much like the RQS bit. Unlike the RQS bit, it is READ ONLY and can be only cleared when the event(s) that caused the service request are cleared.

**ESB** Event Summary Bit 5 (32)

Indicates if an enabled bit in the Standard Event Status Register became set (see Section 4.5.3).

<b>MAV</b>	Message Available Bit 4 (16) Indicates that at least one reply message is waiting in the RPM4 IEEE-488 output queue.
<b>ERROR</b>	Error Queue Not Empty Bit 2 (4) Indicates that at least one command error message is waiting in the RPM4 IEEE-488 error message queue. Use the “ <b>ERR?</b> ” query to get this message.
<b>RSR</b>	Ready Summary Bit 0 (1) Indicates that an enabled bit in the Ready Status Register became set.

### 4.5.3 STANDARD EVENT REGISTER

The RPM4 contains an 8 bit Standard event register that reflects specific RPM4 events. Enabled events in this register will set or clear the ESB bit of the Status Byte Register.

**Table 17.** 8 bit standard event register

<b>PON</b>	<b>URQ</b>	<b>CMD</b>	<b>EXE</b>	<b>DDE</b>	<b>QYE</b>	<b>RQC</b>	<b>OPC</b>
(128)	(64)	(32)	(16)	(8)	(4)	(2)	(1)

This register can be read using the “\*ESR?” query, Each of these status bits can set the ESB bit of the Status Byte Register, causing a SRQ to occur IF the ESB bit is enabled to do so. The Standard Event Status Enable Register (“\*ESE” program message ) determines which of these flags are able to assert the ESB bit. The description of these bits are given as:

<b>PON</b>	Power On Bit 7 (128) Indicates that the RPM4 power has been cycled since the last time this bit was read or cleared.
<b>URQ</b>	User Request Bit 6 (64) Indicates that the RPM4 was set to local operation manually from the front panel by the user (pressing the <b>[ESC]</b> key).
<b>CMD</b>	Command Error Bit 5 (32) Indicates that a remote command error has occurred. A command error is typically a syntax error in the use of a correct program message.
<b>EXE</b>	Execution Error Bit 4 (16) Indicates if a remote program message cannot be processed due to device related condition.
<b>DDE</b>	Device Dependent Error Bit 3 (8) Indicates that an internal error has occurred in the RPM4 such as a transducer time-out.
<b>QYE</b>	Query Error Bit 2 (4) Indicates that an error has occurred in the protocol for program message communications. This is typically caused by a program message being sent to the RPM4 without reading a waiting reply.
<b>RQC</b>	Request Control Bit 1 (2) This bit is not supported as the RPM4 cannot become the active controller in charge.
<b>OPC</b>	Operation Complete Bit 0 (1) Indicates that the RPM4 has completed all requested functions.

## 4.5.4 READY STATUS REGISTER

The RPM4 contains an 8 bit Ready Status Register that reflects specific RPM4 Q-RPT measurement ready events. Enabled events in this register will set or clear the RSB bit of the Status Byte Register.

**Table 18.** 8 bit ready status register

N/A (128)	MEAS LO (64)	NRDY LO (32)	RDY LO (16)	N/A (8)	MEAS HI (4)	NRDY HI (2)	RDY HI (1)
--------------	--------------------	--------------------	-------------------	------------	-------------------	-------------------	------------------

This register can be read using the “\*RSR?” query, Each of these status bits can set the RSB bit of the Status Byte Register, causing a SRQ to occur IF the RSB bit is enabled to do so. The Standard Event Status Enable Register (“\*RSE” program message ) determines which of these flags are able to assert the RSB bit. The description of these bits are given as:

**MEAS LO** Lo-RPT measurement ready Bit 6 (64)

Indicates that the Hi Q-RPT has completed a Q-RPT measurement.

**NRDY LO** Lo Q-RPT pressure Not Ready Bit 5 (32)

Indicates that the Hi Q-RPT made a transition from *Ready* to *Not Ready* as defined by the stability settings (see Section 3.2.1).

**RDY LO** Lo Q-RPT pressure Ready Bit 4 (16)

Indicates that the Hi Q-RPT is *Ready* as defined by the stability settings (see Section 3.2.1).

**MEAS HI** Hi Q-RPT measurement ready Bit 2 (4)

Indicates that the Hi Q-RPT has completed a Q-RPT measurement.

**NRDY HI** Hi Q-RPT pressure Not Ready Bit 1 (2)

Indicates that the Hi Q-RPT made a transition from *Ready* to *Not Ready* as defined by the stability settings (see Section 3.2.1).

**RDY HI** Hi Q-RPT pressure Ready Bit 0 (1)

Indicates that the Hi Q-RPT is *Ready* as defined by the stability settings (see Section 3.2.1).

## 4.6 IEEE STD. 488.2 COMMON AND STATUS PROGRAM MESSAGES

The RPM4 supports a set of commands that are common to all instruments conforming to IEEE Std. 488.2. These command make it easy to perform basic function for any device that supports these commands. These commands also cover the status reporting commands. See Section 4.5 for details on the status registers mentioned in these commands.

**Table 19.** Program message list

<b>*CLS</b>	Clear all of the status & event structures.
<b>*ESE</b>	Read or set the Standard Event Status Enable Register.
<b>*ESR</b>	Read the Standard Event Status Register.
<b>*IDN</b>	Identify the RPM4 version, range, and serial number.
<b>*OPC</b>	Set the operation complete bit when all operations have completed.
<b>*OPT</b>	Read the list of installed RPM4 options.
<b>*RST</b>	Reset the RPM4 settings to factory settings.
<b>*TST</b>	Read the power on self test status.
<b>*SRE</b>	Read or set the Service Request Enable Register.
<b>*STB</b>	Read the Status Byte Register.
<b>*RSE</b>	Read or set the Ready Status Enable Register.
<b>*RSR</b>	Read the Ready Status Register.

### 4.6.1 PROGRAM MESSAGE DESCRIPTIONS

<b>*CLS</b>	
Purpose	Clear all of the status & event structures.
Command	"*CLS"
Remarks	This program message clears the following events and status registers: Standard Byte Register (STB) Standard Event Status Register (ESR) Error Queue Pending OPC operations
Example	Sent:            "*CLS" Reply:           none

<b>*ESE</b>	
Purpose	Read or set the Standard Event Status Enable Register.
Command	"*ESE <i>n</i> "
Query	"*ESE?"
Default	"*ESE 0"
Arguments	<i>n</i> :            '0 to 255' This is the decimal representation of the bit(s) to enable. To enable the PON and QYE bits, the argument would be 128 + 4 = 132.
Remarks	The Standard Event Status Enable register determines which bits in the standard Event Status Register are enabled and included in the Status Byte Register (ESB bit), and can assert the SRQ line. The reply is in decimal numeric form.
Example (enhanced)	Sent:            "*ESE=128"(enables the PON bit) Query reply:    "128" (no reply if IEEE-488)
Errors	ERR# 6: <i>n</i> is not valid.

<b>*ESR</b>	
Purpose	Read the Standard Event Register.
Command	"*ESR?"
Remarks	The Standard Event Register contents are cleared after reading. The reply is in decimal numeric form.
Example (enhanced)	Sent:            "*ESR?" Reply:           "20" (the QYE and EXE bits are set)

<b>*IDN</b>	
Purpose	Identify the RPM4 version, range, and serial number.
Query	"*IDN?"
Remarks	The identification reply is made up of the manufacture, the model, the serial number and the software version. Each is separated by a comma.
Example (enhanced)	Sent: "*IDN?" Reply: "DH INSTRUMENTS INC, RPM4 A0100/A0015, 1234, Ver2.00 -dhf"
<b>*OPC</b>	
Purpose	Sets the operation complete bit when all operations have completed.
Command Query	"*OPC" "*OPC?"
Remarks	This Command enables the RPM4 to set the OPC bit in the Standard Event Status Register when it has completed all pending functions. The Query replies with a "1" when all functions are complete.
Example (enhanced)	Sent: "*OPC" Query reply: "1"
<b>*OPT</b>	
Purpose	Reads the list of installed RPM4 options.
Query	"*OPT?"
Remarks	This Query returns any registered option(s) installed in the RPM4. Each option is separated by a comma. Possible options: "IEEE-488:0" The IEEE-488 option is installed,
Example (enhanced)	Sent: "*OPT?" Reply: "IEEE-488:0"
<b>*RST</b>	
Purpose	Resets the RPM4 settings to factory settings.
Command	"*RST"
Remarks	This Command sets the RPM4 settings to factory settings. This equivalent to a front panel executed RESET/SET. This does not affect the communications settings.
Example (enhanced)	Sent: "*RST" Reply: "*RST" (no reply if IEEE-488)
See Also	Section 3.5.9.1, <a href="#">Reset – Sets</a>
<b>*SRE</b>	
Purpose	Read or set the Service Request Enable Register.
Command Query	"*SRE n" "*SRE?"
Default	"*SRE 0"
Arguments	<i>n</i> : '0 to 255' This is the decimal representation of the bit(s) to enable. To allow the MAV and ESB bits to assert the SRQ line, the argument would be 32 + 16 = 48. Bit 6 (64) is reserved and cannot be set.
Remarks	The Service Request Enable Register determines which bits of the Status Byte can set the MSS bit of the Status Byte and request service by asserting the SRQ line of the IEEE-488 interface.
Example (enhanced)	Sent: "*SRE=48" (enables the MAV and ESB bits) Query reply: "48" (no reply if IEEE-488)
Errors	ERR# 6: <i>n</i> is not valid.
<b>*STB</b>	
Purpose	Read the Status Byte Register.
Command	"*STB?"
Remarks	The Status Byte Register reflects the general status of the RPM4. The 'MSS' bit state is represented by bit 6.
Example (enhanced)	Sent: "*STB?" Reply: "80" (The MSS and MAV bits are set)
<b>*TST</b>	
Purpose	Read the power on self test status.
Query	"*TST?"
Remarks	The RPM4 system memory stores the user settings (units, resolution) and retains them when the unit is OFF. On power-up, this memory is checked. If this memory is corrupted, all user settings are reset to default (as if the "*RST" program message was executed), and the *TST query will return a non zero value. If the RPM4 passed the test on power-up OR if the *TST query was used at least once since the RPM4 was powered up the reply will be a '0'.
Example (enhanced)	Sent: "*RST?" Reply: "1"



<b>*RSE</b>	
Purpose	Read or set the Ready Status Enable Register.
Command Query	"RSE <i>n</i> " "RSE?"
Default	"RSE 0"
Arguments	<i>n</i> : '0 to 255' This is the decimal representation of the bit(s) to enable. To enable the RDY bit, the argument would be 1.
Remarks	The Ready Status Enable Register determines which bits in the Ready Status Register are enabled and included in the Status Byte Register (RSR bit), and can assert the SRQ line. The reply is in decimal numeric form.
Example (enhanced)	Sent: "*RSE=1" (enables the RDY bit) Query reply: "1" (no reply if IEEE-488)
Errors	ERR# 6: <i>n</i> is not valid.

<b>*RSR</b>	
Purpose	Read the Ready Status Register.
Command	"RSR?"
Remarks	The Ready Status Register contents are cleared after reading. The reply is in decimal numeric form.
Example (enhanced)	Sent: "RSR?" Reply: "6" (The MEAS and NRDY)

## NOTES

# 5. MAINTENANCE, ADJUSTMENTS AND CALIBRATION

## 5.1 OVERVIEW

RPM4 A70M/A20M-AF was designed for maintenance free operation. No maintenance is required other than:

- Regular AutoZeroing of quartz reference pressure transducers (Q-RPTs) (see Section 3.5.1).
- Periodic calibration of Q-RPTs (see Section 5.3).
- Adjustment of the on-board barometer (see Sections 5.2.2).

From a maintenance, calibration and repair point of view, the RPM4 and HPMS are treated as separate sub-systems.



*RPM4/HPMS A70M/A20M-AF is a sophisticated pressure measuring instrument with advanced on-board features and functions. Before assuming that unexpected behavior is caused by a system defect or failure, use this manual and other training facilities to become thoroughly familiar with RPM4 operation.*

*For rapid assistance in specific situations see Chapter 6 for troubleshooting information.*

---



*RPM4 is covered by a limited one (1) year warranty. Unauthorized service or repair during the warranty period is undertaken at the owner's risk and may cause damage that is not covered under warranty and/or may void the warranty. For warranty service, contact a DHI Authorized Service Provide (see Table 23).*

---

## 5.2 RPM4 MAINTENANCE

### 5.2.1 AUTOZERO OF Q-RPTS

See Section 3.5.1 for complete information on Autozeroing of RPTs.

#### 5.2.1.1 GAUGE MODE AUTOZERO

Since gauge mode AutoZeroing is so easily performed, it is good practice to AutoZero whenever the RPM4 is vented (open to atmosphere). Before AutoZeroing, allow at least two minutes for full system stabilization after venting; be sure that the pressure applied is truly zero (i.e., the RPT is truly vented/connected to atmosphere with no back pressure) and be sure to consider the influence of fluid heads.

To cause the range to Autozero, press **[AutoZ]**.

If the RPM4 is used only in gauge mode, Autozeroing in absolute mode is not necessary and vice-versa. Gauge and absolute mode Autozeroing are completely independent one from the other.

See Section 3.5.1 for complete information on Autozeroing of RPTs.

### 5.2.1.2 ABSOLUTE MODE AUTOZERO

When operated in absolute mode, a Q-RPT should be Autozeroed about once a month or when the RPM4 has been exposed to a temperature change exceeding 15 °C (36 °F). Whether or not AutoZeroing is necessary can also be evaluated by comparing the reading of the RPM4 Q-RPT to the reading of a barometer when the RPM4 is vented at atmospheric pressure. The barometer should have measurement uncertainty of 0.04 psi (0.28 kPa) or better. For the Lo Q-RPT, if the disagreement is greater than 0.05 psi (0.35 kPa), the Q-RPT should be rezeroed against the barometer. For the Hi Q-RPT, if the disagreement is greater than 0.15 psi (1 kPa), it should be rezeroed against the Lo Q-RPT or against the barometer.

Follow the procedures described in Section 3.3.9.2 to perform absolute mode Autozeroing.

## 5.2.2 ADJUSTMENT OF THE ON-BOARD BAROMETER

### ○ PURPOSE

To adjust the output of the on-board barometer (see Section 3.5.7.1).

### ○ PRINCIPLE

The on-board barometer output can be adjusted using PA and PM values following the same principles as for the Q-RPTs (see Section 5.3.1.1).

Since the on-board barometer is not a source of traceable pressure values, it does not have to be formally calibrated. It should be offset to agree with a reference barometer. To offset the barometer, change the barometer pressure adder (PA).



*The on-board barometer is used only for measuring changes in atmospheric pressure over short periods of time (see Section 3.2.3). RPM4 measurement accuracy does NOT depend on the absolute accuracy of the on-board barometer.*

---

### ○ OPERATION

To view or edit the values of PA and PM for RPM4's on-board barometer, press **[SPECIAL]**, **<8cal>**, **<3barometer>**. Pressing **[ENT]** steps through displays of the calibration date [YYYYMMDD] and PA and PM. In **edit** mode, the values can be edited. Pressing **[ENT]** after the last screen activates the edited values.



*To view the current output of the on-board barometer, press **[SPECIAL]**, **<7Internal>**, **<3baro>** from the main run screen.*

---



*A pressure standard may be connected to the on-board barometer by connecting to one of the ATM ports on the RPM4 rear panel Q-RPT modules (10-32 UNF). The operating span of the barometer is 10 psi (70 kPa) to 16 psi (110 kPa).*

---



*Never apply a pressure greater than 16 psi (110 kPa) to the barometer port. Overpressure and possible damage may result.*

---

## 5.3 RPM4 Q-RPT CALIBRATION

### 5.3.1 PRINCIPLE

RPM4 A70M/A20M-AF has two quartz reference pressure transducers (RPTs) that are the source of low pressure measurement uncertainty for the system.

To adjust a Q-RPT, pressures from a reference standard are applied to the Q-RPT at ascending and descending pressure increments over the range. The pressure defined by the standard and the corresponding Q-RPT readings are recorded at each point. After all of the pressures have been applied and recorded, adjustments are made to fit the Q-RPT pressure readings to the standard. Fitting the readings means performing a least squares linear regression to arrive at the lowest value of the residuals of errors of the Q-RPT relative to the standard. The Q-RPT output is adjusted by user settable coefficients: PA (an adder or offset) and PM (a multiplier or span set) (see Section 5.3.1.1).

The calibration process is performed independently on each Q-RPT to arrive at its optimal fit.

RPM4 is delivered with an interactive Q-RPT calibration utility (CalTool for RPTs) that steps the operator through the complete Q-RPT calibration procedure including applying the necessary pressures, collecting data automatically, calculating new PA and PM values, previewing the results of the new calibration and activating the results of the new calibration (see the CalTool for Q-RPTs manual on the RPM4 A70M/A20M-AF Support Disk). RPM4 also provides complete front panel and remote access to Q-RPT calibration parameters so that Q-RPT calibrations can be performed without using CalTool software (see Section 5.3.8).



*CalTool for RPTs software supports the calibration process of RPM4 Q-RPTs. CalTool and its documentation are provided on the RPM4 A70M/A20M-AF Support Disk which is delivered with a new RPM4 A70M/A20M-AF. CalTool for RPTs can also be downloaded from [www.dhstruments.com](http://www.dhstruments.com). The use of CalTool software to assist in the calibration of RPM4 is highly recommended.*

---

If RPM4 will be used in both gauge and absolute measurement modes, it must be calibrated in absolute measurement mode, applying absolute pressures. If RPM4 will be used in gauge measurement mode only, it may be calibrated in gauge mode by applying gauge pressures. In this case, it will no longer have known measurement uncertainty in absolute mode and access to absolute mode operation should be turned OFF (see Section 5.3.5).

#### 5.3.1.1 PA AND PM COEFFICIENTS

The coefficients used to adjust Q-RPT readings are designated PA (an adder or offset) and PM (a multiplier or span set). The coefficients affect the Q-RPT reading following:

$$\text{Corrected reading} = (\text{uncorrected reading} \cdot \text{PM}) + \text{PA}$$

PA is expressed in units of pressure (always the SI unit, Pascal).

PM is dimensionless.

Each Q-RPT has its own unique PA and PM values. The PA and PM values currently in use can be viewed and edited from the front panel in the CAL function (see Section 5.3.7). PA and PM values are automatically edited when CalTool software results are activated.



As editing PA and PM values changes Q-RPT calibration, they should only be edited by qualified personnel as part of the calibration process. Caution should be taken to avoid accidental editing and a security system is available to prevent access (see Section 3.5.5.5). Incorrect editing of PA and PM values can cause out of tolerance measurements.

---



A new RPM4 is delivered with PA and PM values set to zero and 1 for all Q-RPTs. This does not mean that the RPM4 has not been calibrated. In the original factory calibration, privileged factory coefficients are used for calibration with the user PA and PM set to zero and 1.

---

### 5.3.1.2 AS RECEIVED AND AS LEFT DATA

Frequently, calibration procedures require that as received and as left data be reported. The necessary information to report as received and as left data on the calibration of RPM4 Q-RPTs can be obtained in several ways.

When the RPM4 CalTool calibration assistance software is used, as received data is displayed while running the calibration and is automatically recorded and reported if desired. As left data is also calculated and presented.

At any time, a) reference pressures applied; b) associated Q-RPT readings; c) PA, PM and  $P_{\text{offset}}$  (AutoZ offset) values, can be used to calculate as received and as left values. For example, backing out PA and PM on the as left data yields the Q-RPT readings with PA = 0 and PM = 1. Then applying the as received PA, PM and  $P_{\text{offset}}$  values to the readings calculates as *received* readings (the readings that the transducer would have made with the old PA, PM and  $P_{\text{offset}}$ ).

---



It is recommended that “as received” values of PA, PM and  $P_{\text{offset}}$  be recorded for each range prior to running the calibration. The current PA, PM and  $P_{\text{offset}}$  can be viewed by pressing [SPECIAL], <8cal>, <1view>.  $P_{\text{offset}}$  is only relevant if absolute mode AutoZero is used in normal operation.

---

### 5.3.2 EQUIPMENT REQUIRED



The recommended calibration standard for the RPM4 A70M/A20M-AF Q-RPTs is a DHI PG7202 piston gauge with a DHI RPM4 A100K reference pressure monitor connected to the PG7202 as its external barometer. Contact DHI for additional information.

---

**Gas** operated piston gauge (deadweight tester), with the following characteristics:

---



Do not put oil or other liquids into RPM4 A70M/A20M-AF Q-RPTs.

---

- **Measurement uncertainty of  $\pm 0.005$  % of reading or better.** A standard with higher measurement uncertainty may be used but RPM4 measurement uncertainty may be degraded proportionally from normal specifications.
- **Able to apply absolute pressures.** If, after calibration, the RPM4 will be used in absolute measurement mode, the calibration must be performed using absolute

pressures. Absolute pressures are defined by adding atmospheric pressure measured by a barometer to gauge pressure defined by the piston gauge. If, after calibration, the RPM4 will not be used in absolute measurement mode (as is often the case for higher pressure Q-RPTs) it may be calibrated in gauge mode using a gauge pressure standard.



*Q-RPTs calibrated in gauge measurement mode by applying gauge reference pressure values should be used in gauge mode only (see Sections 3.3.3, ○ PRINCIPLE, 5.3.5).*

---

- **Able to supply the recommended sequence of pressure points in the range to be calibrated:** See Section 5.3.4 for information on the recommended calibration point sequence.

### 5.3.3 SET-UP AND PREPARATION

To set-up and prepare the RPM4 for calibration of its Q-RPTs:



*THE RPM4 SHOULD NOT BE REMOVED FROM THE HPMS BRACKET FOR CALIBRATION. THE RPM4/HPMS SHOULD ALWAYS BE KEPT TOGETHER AS AN INTEGRATED UNIT UNLESS DISASSEMBLY IS REQUIRED FOR MAINTENANCE OR REPAIR.*

---

- ❶ Set the RPM4/HPMS on a stable surface near the calibration standard at a height as close as possible to the calibration standard's reference height. Consider the high pressure gas connection that needs to be made to the **TEST** port on the rear of the HPMS and access to the front panel display, keypad and Lo Q-RPT isolation valve.
- ❷ Connect the calibration standard output to the HPMS rear **TEST** port. The **TEST** port connection is DH500 F (DH500 F: gland and collar type fitting for coned and left hand threaded 1/4 in. OD tube, equivalent to AE F250C, HIP HF4, etc.). The HPMS **TEST** port connects to BOTH of the RPM4 A70M/A20M-AF quartz reference pressure transducers (see Section 3.2.5).



*Take care to avoid overpressure of the Lo Q-RPT (A20M with maximum pressure of 3 000 psi). The HPMS rear TEST port connects to both the A20M (3 000 psi) and the A70M (10 000 psi) Q-RPTs. Use the Lo RPT Isolation Valve on the HPMS front panel to isolate the Lo RPT when applying pressure to the Hi RPT (see Section 3.2.5). If RPM4 is removed from the HPMS, note that the RPM4 has separate Lo and Hi TEST(+) ports, one for each Q-RPT. Exposing the Lo RPT to pressure greater than 3 600 psi (24 MPa) may damage it beyond repair. The product warranty does not cover Q-RPT damage due to overpressure.*

---

### 5.3.4 RECOMMENDED CALIBRATION POINT SEQUENCE

Calibration adjustments to RPM4 Q-RPTs are made by altering calibration coefficients, PA and PM (see Section 5.3.1.1). To adjust these coefficients to optimum values giving the best results over the Q-RPTs' complete operating range, the specific calibration point sequence defined in Table 20 is recommended.

Prior to running the calibration point sequence, the Q-RPT should be exercised:

- a) Set full scale pressure.
- b) Dwell at full scale pressure for 5 minutes.
- c) Return to atmospheric pressure (vented).
- d) Dwell for ten (10) minutes.

A dwell time of 60 seconds is recommended before taking data at each pressure increment.



The calibration pressure standard is not required to apply precisely the nominal pressure value of each calibration point as long as the exact value of the applied pressure is known. Best results are obtained if the actual applied pressure is within 5 % of the recommended nominal point.

**Table 20.** Calibration point sequence for A20M and A70M Q-RPTs

CALIBRATION SEGMENT	POINT NO.	POINT [% OF SPAN]
Ascending	1	Atmospheric pressure
	2	25 %
	3	50 %
	4	75 %
	5	100 %
Descending	6	75 %
	7	50 %
	8	25 %
	9	Atmospheric pressure



A Q-RPT that will NOT be used in absolute measurement mode after calibration may be calibrated in gauge measurement mode with a gauge pressure standard. The Q-RPT should then be used in gauge mode only (see Sections 3.3.3, ○ PRINCIPLE, 5.3.5).

### 5.3.5 TURNING OFF ABSOLUTE MODE CAPABILITY FOR A Q-RPT

#### ○ PURPOSE

To prevent operation in absolute measurement mode on a Q-RPT that has been calibrated for gauge mode only.

#### ○ PRINCIPLE

RPM4 A70M/A20M Q-RPTs are frequently used in gauge measurement mode only (see Section 3.3.3, ○ PRINCIPLE). Q-RPTs that are used in gauge mode only, may be calibrated in gauge mode with a reference that applies gauge pressures. Calibration with an absolute reference is not necessary. However, if a Q-RPT is calibrated in gauge mode, it is not possible to know if it is in or out of tolerance in absolute modes. To avoid using absolute mode with a Q-RPT that is calibrated for gauge mode only, access to absolute mode can be turned OFF. This is accomplished in the **[SPECIAL], <8cal>** menu.



## ○ OPERATION



See Section 5.3.7 for more detailed information on editing and viewing Q-RPT calibration information.

Turning absolute mode operation ON and OFF for a Q-RPT occurs in the same area in which calibration coefficients are edited. To access the Q-RPT calibration editing area press **[SPECIAL]**, **<8cal>** and select the desired Q-RPT. Then select **<1edit>** to make changes.

**[ENT]** through the calibration information screens. After viewing the values of PA and PM the display is:

Allow absolute	Hi
meas mode:	1off 2on

The cursor is on the number corresponding to the current selection. Make the desired selection. **<1no>** causes absolute mode to be unavailable for the Q-RPT.

### 5.3.6 Q-RPT CALIBRATION USING CALTOOL FOR Q-RPTS SOFTWARE

To calibrate RPM4 Q-RPTs using CalTool software, refer to Sections 5.3.1, 5.3.2, 5.3.3 and 5.3.4 in this manual and then refer to the CalTool for Q-RPTs Software Manual.

CalTool for Q-RPTs software and manual are supplied on the RPM4 A70M/A20M Support Disk and can be downloaded from [www.dhstruments.com](http://www.dhstruments.com).

### 5.3.7 EDITING AND VIEWING Q-RPT CALIBRATION INFORMATION

#### ○ PURPOSE

View and/or edit Q-RPT calibration information fields including:

- **The calibration date** – This field is normally used to record the date on which the Q-RPT is calibrated.
- **The value of absolute mode AutoZero P<sub>offset</sub>** – See Section 3.5.1 for complete AutoZero information. This value is must be set to zero for a Q-RPT that just been calibrated. It should be set to zero before making adjustments.
- **The value of PA** – The pressure adder for the selected Q-RPT (see Section 5.3.1.1).
- **The value of PM** – The pressure multiplier for the selected Q-RPT (see Section 5.3.1.1).
- **Absolute measurement mode ON or OFF** – See Section 3.3.3, ○ PRINCIPLE for complete information on measurement modes. This is set to OFF if a Q-RPT was calibrated in gauge mode with a gauge pressure standard.

#### ○ OPERATION



As editing PA and PM values will change the calibration of the Q-RPTs, the edit function should only be used by qualified personnel as part of the calibration process. Caution should be taken to avoid accidental editing. A user level security system is available to control access (see Section 3.5.5.5).



A new RPM4 is delivered with PA and PM values set to zero and 1 for all ranges. This does not mean that the RPM4 has not been calibrated. In the original factory calibration, privileged factory coefficients are used for calibration with the user PA and PM set to zero and 1.

To access Q-RPT calibration information viewing or editing press **[SPECIAL]**, **<8Cal>**. Select the desired Q-RPT. The **<1view>** selection displays the calibration information fields. The **<2edit>** function displays the fields and allows them to be edited. The display is:

1. Date of last calibration in YYYYMMDD format.
2. Position designator of the Q-RPT being viewed.
3. Current value of absolute mode  $P_{offset}$ .

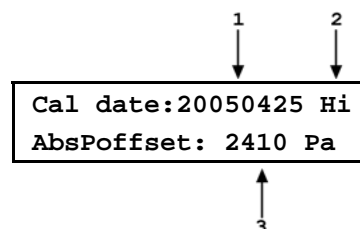

If in **edit** mode, the calibration information fields can be edited. Edits to  $P_{offset}$  are common with the AutoZ edit or run function (see Sections 3.3.9, 3.5.1). Pressing **[ENT]** on the last field goes to the next view/edit screen:

1. Value of PA.
2. Position designator of the Q-RPT being viewed.
3. Value of PM.

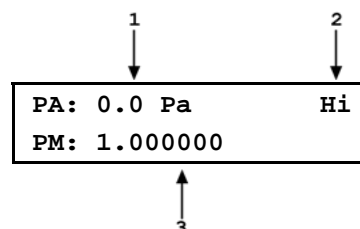

If in **edit** mode, the calibration fields can be edited. If the selected Q-RPT is an Axxx Q-RPT, pressing **[ENT]** in the PM field goes to the next calibration information display (this display is skipped if the Q-RPT is a Gxxx or BGxxx type):

1. Position designator of the Q-RPT being viewed.
2. Cursor is on current ON or OFF selection.

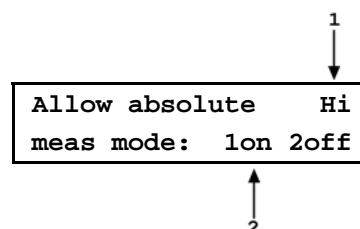

The cursor is on the current setting. If in **edit** mode, the ON or OFF status can be changed by selecting **<1on>** or **<2off>** (see Section 5.3.5). **[ENT]** in view mode returns to the view/edit screen. **[ENT]** in edit mode goes to confirmation of change activation if changes have been made in any of the calibration screens. Pressing **[ESC]** in any edit screen exits the edit screen without activating any changes.



The value of PA is always in Pascal (Pa). The value of PM is dimensionless.

### 5.3.8 Q-RPT ADJUSTMENT WITHOUT CALTOOL FOR Q-RPTS SOFTWARE

#### ○ PRINCIPLE

The RPM4 Q-RPTs can be adjusted without using CalTool for Q-RPTs software. This requires:

- Setting  $P_{offset}$  to zero.
- Applying pressures with a calibration standard and recording the pressures measured by RPM4.
- Calculating new PA and PM values and entering them.



Before proceeding to adjust a Q-RPT without using CalTool for Q-RPTs software, Sections 5.3.1, 5.3.2, 5.3.3 and 5.3.4.

## ○ OPERATION

The typical procedure for adjusting a Q-RPT is:

- ❶ Set-up and prepare the RPM4 for calibration (see Sections 5.3.2, 5.3.3).
- ❷ Use the **[RANGE]** function key to select the Q-RPT to be calibrated (see Section 3.3.1). Be sure to set the DF range (not an AutoRanged range).
- ❸ Use **[HEAD]** to set the HEAD to zero (see Section 3.3.7). Use **[UNIT]** to set the desired pressure unit of measure (see Section 3.3.2). Use **[MODE]** to set the desired pressure measurement mode (see Section 3.3.3). Q-RPTs that will be used in gauge measurement mode only after the adjustments are made, may be calibrated in gauge measurement mode with a gauge pressure standard (see Section 5.3.5).
- ❹ Use **[SPECIAL]**, **<1AutoZ>** to access the AutoZ function (see Section 3.5.1). Turn AutoZ OFF. If you are only verifying the Q-RPT, “as received” prior to adjustments, leave AutoZ ON.
- ❺ Use **[SPECIAL]**, **<8cal>**, **<1Hi Q-RPT >** or **<2Lo Q-RPT >**, **<1edit>**, to read and record the current values of PA and PM for the Q-RPT to be calibrated. If verifying a calibration in absolute mode, also record the value of  $P_{\text{offset}}$ .
- ❻ Run the recommended calibration point sequence for the Q-RPT (see Section 5.3.4). Record the pressure applied by the standard and the RPM4 reading at each calibration point. Dwell at least 60 seconds at each point after setting the reference pressure to allow full stabilization.
- ❼ Enter the calibration pressures and RPM4 readings into a spreadsheet. Calculate the “non-corrected” RPM4 readings by backing out the PA and PM recorded in Steps ❸ and ❹ above, following:

$$\text{non-corrected reading} = (\text{corrected reading} - \text{PA})/\text{PM}$$

If calibrating in absolute mode, AutoZ was ON and the value of  $P_{\text{offset}}$  was not set to zero, also add the value of  $P_{\text{offset}}$  to each reading.

- ❽ Perform a linear regression to find the offset and slope that best fit the non-corrected RPM4 readings to the calibration standard pressures. The offset is the new value of PA, the slope is the new value of PM.
- ❾ Press **[SPECIAL]**, **<8Cal>**, **<1Hi Q-RPT >** or **<2Lo Q-RPT >**, **<2edit>** and write the new calibration date and the new values of PA and PM for the Q-RPT calibrated (see Section 5.3.7). If the calibration was performed in gauge mode, turn absolute mode OFF so it won't be used after the calibration.
- ❿ Calculate as left data for the calibration if desired following:

$$\text{as left reading} = (\text{non-corrected reading} \cdot \text{new PM}) + \text{new PA}$$

- ⓫ Perform additional verification pressure runs as desired.

## 5.4 RPM4 REPAIR

### 5.4.1 REMOVING RPM4 FROM HPMS

---



The RPM4/HPMS is an integrated assembly. The RPM4 should not be removed from the HPMS unless it is necessary for RPM4 and/or HPMS repairs. The RPM4 should be calibrated in the HPMS mounting system as the RPM4 orientation may affect its calibration.

---

To remove the RPM4 A20M/A70M-AF from the HPMS High Pressure Mounting System, proceed as follows (numerical references refer to Figure 12):

- ❶ Turn the HPMS upside down. Set it on its top on a flat surface.
- ❷ Disconnect the J1 ACC. circular connector from the RPM4 rear panel and remove the RPM4 power cable.
- ❸ Remove the Lo Q-RPT connection tube (5): Fully loosen the Lo Q-RPT **TEST(+)** connection on the RPM4 rear panel (3). Use a 7/16 in. wrench to loosen the swage nut (3). Do not remove the NPT thread adapter that is in the Q-RPT **TEST(+)** port.  
  
Fully loosen the gland nut (6) connecting the Lo Q-RPT connection tube (5) to the Lo Q-RPT isolation valve rear port (6). Use a 1/2 in. wrench.  
  
Gently pull the Lo Q-RPT connection tube (5) away from the RPM4 rear panel adapter (3) until the tube tip is free from the adapter in the Lo Q-RPT **TEST(+)** port.
- ❹ Remove the Hi Q-RPT connection tube (9): Fully loosen the Hi Q-RPT **TEST(+)** connection on the RPM4 rear panel (2). Use a 7/16 in. wrench to loosen the swage nut (2). Do not remove the NPT thread adapter that is in the Q-RPT **TEST(+)** port.  
  
Fully loosen the gland nut (7) connecting the Hi Q-RPT connection tube (9) to the Lo Q-RPT isolation valve side port (7).  
  
Fully loosen the gland nut (1) connecting the Hi Q-RPT connection tube (9) to the HPMS rear panel **TEST** port adapter (1). Use a 5/8 in. wrench.  
  
Carefully pull the Hi Q-RPT connection tube (9) out of the valve side port (7). Then, gently pull the tube away from the RPM4 rear panel adapter (2) until the tube tip is free from the adapter.
- ❺ Remove the four nuts and lock washers (8) that hold the RPM4 rack mount brackets (10) to the front of the HPMS bracket. Use a 7 mm wrench.
- ❻ Loosen but do not remove the two nuts and lock washers (13) that hold the RPM4 rear support bracket (12) to the rear of the HPMS bracket. Use a 7 mm wrench.  
  
Remove the four screws and washers (11) that hold the RPM4 rear support bracket (13) to the RPM4 rack mount brackets (10). Use a 3 mm allen wrench.
- ❼ Grasp the RPM4 (4) and rack mount brackets (10) and move them away from the front of the HPMS bracket and studs (8). The rear support bracket (13) should move away freely because of the loosened nuts (13) holding it onto the HPMS brackets.
- ❽ Once the rack mount brackets (10) clear the studs (8), the brackets can be removed from the RPM4 and the RPM4 can move to the side out of the HPMS. Take care not to drop the RPM4 when removing the rack mount brackets.
- ❾ To reassemble, reverse the procedure. When reassembling the high pressure gland and collar fittings, protect the conical tip from damage and be sure that the collar is fully threaded on the nipple (left hand thread) before tightening the gland nut. Leak check all connections after reassembly.

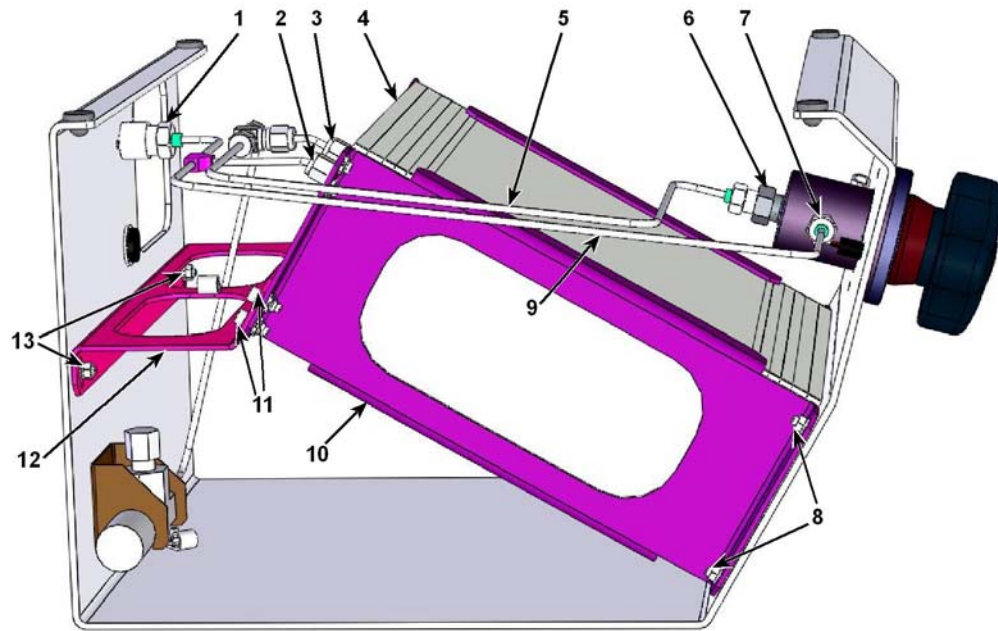

- |   |  |
|---|--|
| 1. HPMS TEST port connection            | 8. RPM4 rack mount/HPMS connection                     |
| 2. RPM4 Hi Q-RPT connection             | 9. TEST port (DH500 F)                                 |
| 3. RPM4 Lo Q-RPT connection             | 10. Hi Q-RPT connection tube                           |
| 4. RPM4 A70M/A20M-AF                    | 11. Rack mount bracket/rear support bracket connection |
| 5. Lo Q-RPT connection tube             | 12. Rear support bracket                               |
| 6. Lo RPT shutoff valve rear connection | 13. Rear support bracket/HPMS connection               |
| 7. Lo RPT shutoff valve side connection |  |

Figure 12. RPM4/HPMS disassembly view

### 5.4.2 OPENING AND CLOSING THE RPM4 ENCLOSURE

To open the RPM4 case, first remove the RPM4 from the HPMS (see Section 5.4.1). Once the RPM4 is removed from the HPMS, proceed as follows:

- ❶ Place the RPM4 bottom side up on a stable, flat surface.
- ❷ Remove the four (4) Phillips head screws at the four corners of the RPM4 bottom panel.
- ❸ Remove the four plastic feet by sliding the away from the case. Do not pull them straight up as this will damage their retaining tab.
- ❹ While holding the bottom panel and cover together, turn the RPM4 over and place it bottom side down.
- ❺ Lift the top cover off of the bottom panel leaving the front and rear panels behind with the bottom panel. The front and rear panel fit into guide slots on the top cover.
- ❻ To reassemble, reverse the procedure. Before putting the cover on, check that the front is well seated in its guide slots on the bottom panel.

### 5.4.3 RELOADING EMBEDDED SOFTWARE INTO FLASH MEMORY

RPM4 uses FLASH memory. This allows the embedded software that controls RPM4 operations and functions to be loaded into RPM4 over its COM1 port from a computer with a simple FLASH loading utility program.

To replace corrupted software or upgrade your software, access the **DHI** web site at [www.dhainstruments.com](http://www.dhainstruments.com) and go to **SOFTWARE**. A FLASH loading utility and the latest RPM4 software are available for download at no charge. If you do not have access to the

web or have difficulty downloading or loading software, contact your **DHI** representative or a **DHI** Authorized Service Provider (see Table 23) for assistance.

If you believe you have discovered an error or “bug” in RPM4 software, please report it with complete details by email to [cal.repair@dhinstruments.com](mailto:cal.repair@dhinstruments.com).



The DHI flash software loading utility and RPM4 embedded software are available for download from [www.dhinstruments.com](http://www.dhinstruments.com) in the SOFTWARE section.

#### 5.4.4 SUBASSEMBLY DESCRIPTION AND LOCATION

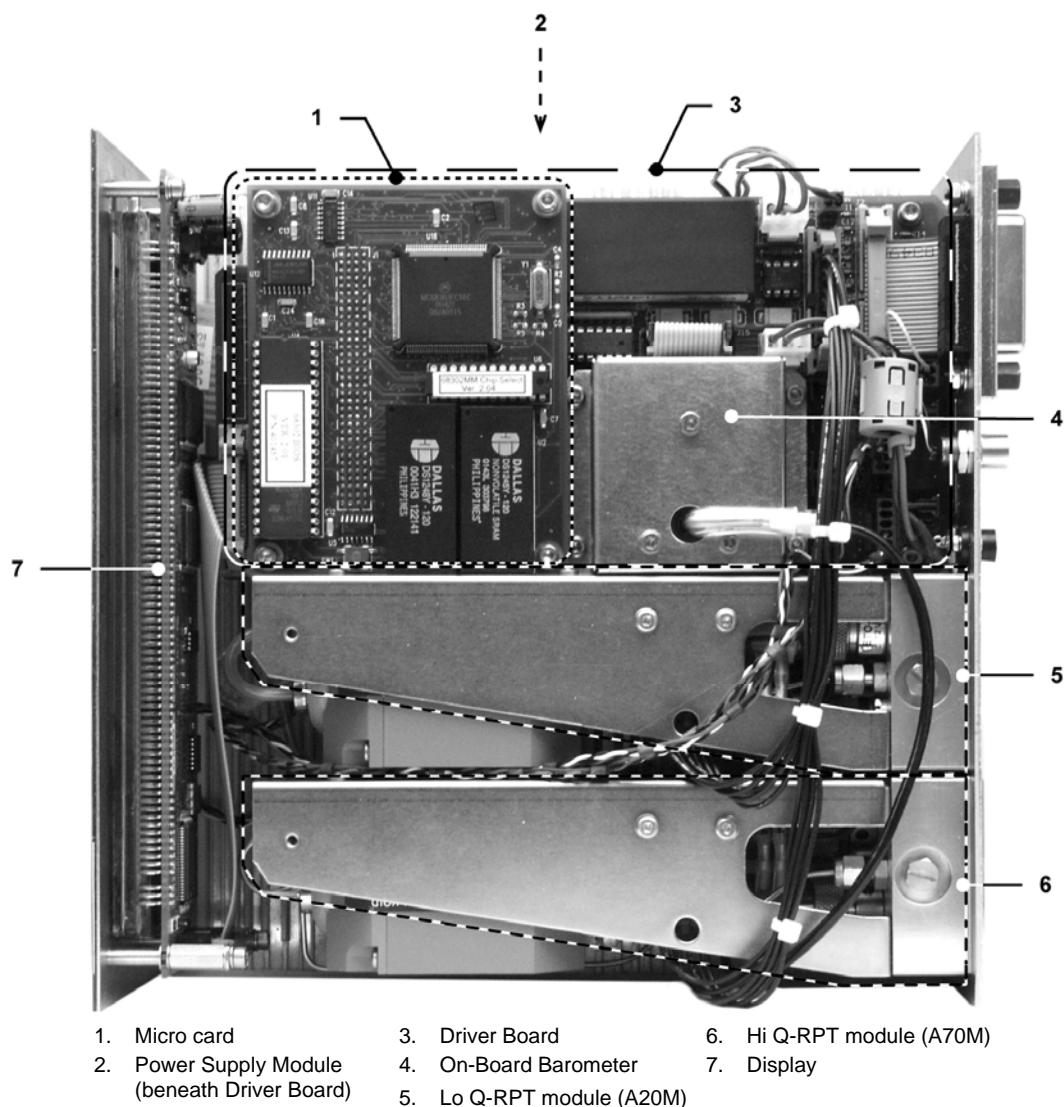

**Figure 13.** RPM4 internal view

##### 5.4.4.1 MICRO BOARD

The micro board supports a Motorola 68302 micro-controller, EPROM, EEPROM, 128k x 16 bit NVRAM, 8 Mbit flash memory; RS-232 and IEEE-488.2 communications; keypad and display control. An I/O port controls other ports and devices in RPM4.

#### 5.4.4.2 POWER SUPPLY MODULE

+ 12 V DC ( $\pm 2\%$ ) @ 2.1 Amps

#### 5.4.4.3 DRIVER BOARD

The driver board is controlled by the mini micro board (see Section 5.4.4.1). It supports:

- Frequency counters (2) for reading Q-RPTs (see Section 5.4.4.5)
- On-board barometer power and output (see Section 5.4.4.4)
- Power to the system cooling fan
- Remote **[ENT]**
- Keypad and display
- Beeper

#### 5.4.4.4 ON-BOARD BAROMETER

The on-board barometer supports a board mounted, barometric range, micromachined silicon sensor and an ambient temperature sensor. The barometer readings are used for dynamic atmospheric pressure compensation when measuring gauge pressure with an absolute quartz reference pressure transducer (see Section 3.2.2). The temperature sensor is used for temperature compensation of the barometric sensor.

#### 5.4.4.5 Q-RPT MODULE

The Q-RPT module is an integrated Quartz Reference Pressure Transducer (Q-RPT) assembly. The module includes a Q-RPT, brackets to hold the transducer, interconnecting tubing and a manifold with **TEST(+)** and **ATM** ports.

A Q-RPT provides very high precision, low uncertainty pressure measurement. The basic sensing principle is the measurement of the change in the natural oscillating frequency of a quartz tuning fork in response to changes in temperature and mechanical stress resulting from the change in pressure applied to a connecting bellows or bourdon tube. Two independent quartz elements are used. One quartz element is subjected to pressure related stress. The other quartz element is used only to monitor temperature. See Section 1.2.2.1 for Q-RPT specifications.

See Section 5.4.5, Figure 14 for a pneumatic schematic of the Q-RPT module configuration.

##### **HI Q-RPT MODULE**

The RPM4 A70M/A20M-AF Hi Q-RPT is an A70M. The A70M has a pressure range of atmosphere to 10 000 psi (70 MPa) absolute, 0 to 10 000 psi (70 MPa) gauge.

##### **LO Q-RPT MODULE**

The RPM4 A70M/A20M-AF Lo Q-RPT is an A20M. The A20M has a pressure range of atmosphere to 3 000 psi (20 MPa) absolute, 0 to 3 000 psi (20 MPa) gauge.

#### 5.4.4.6 DISPLAY

2 x 20 character vacuum fluorescent display.

### 5.4.4.7 COOLING FAN

The cooling fan is mounted on the RPM4 rear panel and connected to the main board. It is a 12V brushless DC fan.

### 5.4.5 Q-RPT MODULE PNEUMATIC SCHEMATIC

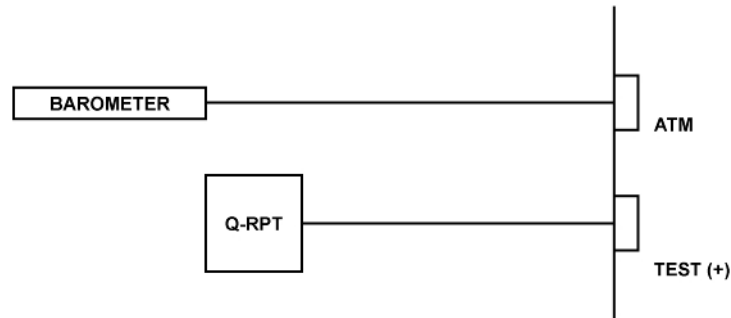

Figure 14. Pneumatic schematic of RPM4 Q-RPT Module

## 5.5 RPM4 ILLUSTRATED PARTS BREAKDOWN

Table 21. RPM4 Front Panel Illustrated Parts Breakdown (see Figure 15)

# REQUIRED	DESCRIPTION	PART NO.
1	Enclosure, top	103041
4	Feet, set	103042
4	Screw, feet	103295-z
1	Key pad overlay	123560

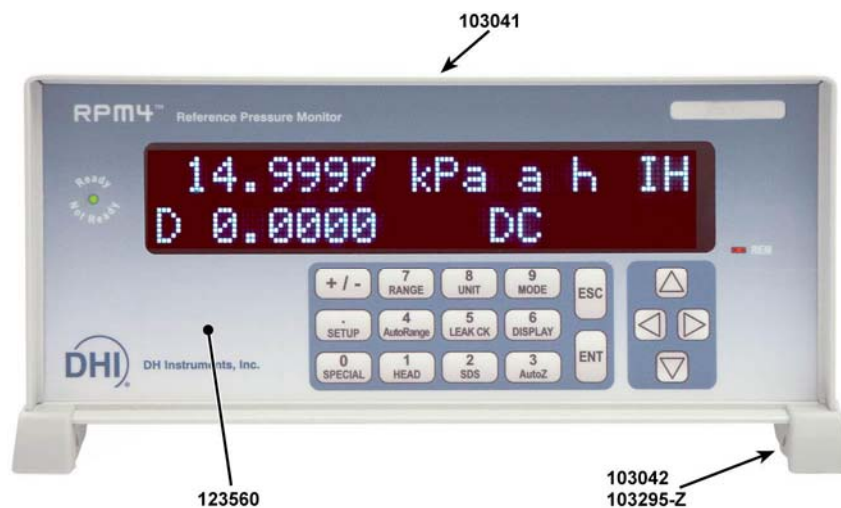

Figure 15. RPM4 Illustrated Parts Breakdown of Front Panel



Table 22. RPM4 Rear Panel Illustrated Parts Breakdown (see Figure 16)

# REQUIRED	DESCRIPTION	PART NO.
1	Rear panel	124154
8	Screw	.30C100MXFS
1	Fan	D2510M12B
1	Fan guard	JGW25
2	Screw	.25C160MXPS
1	Power entry module	06AK2D
2	Fuse,1A/250V,SLO-BLO,5X20	218001
1	DC power jack	103285
1	IEEE-488 assembly	401420
2	Screw lock kit	102073
1	J1 Accessory assembly	402195
2	Adaptor	2CM2-316

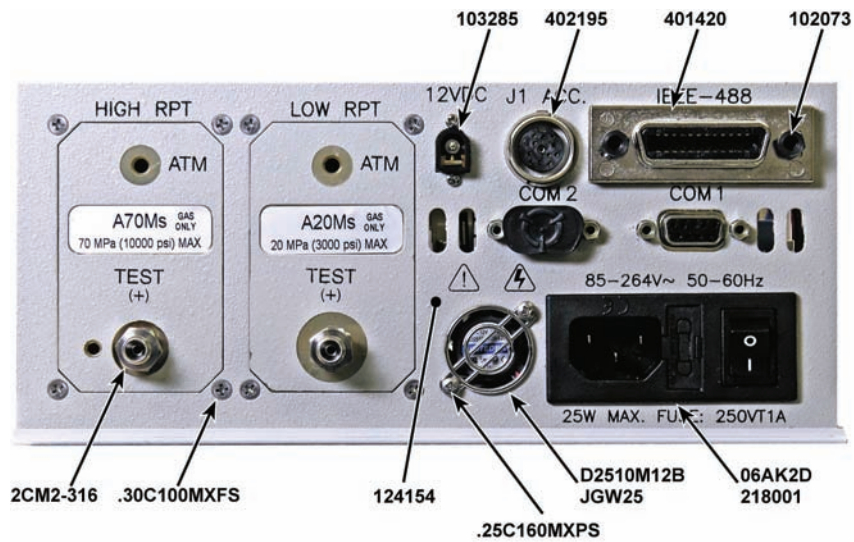
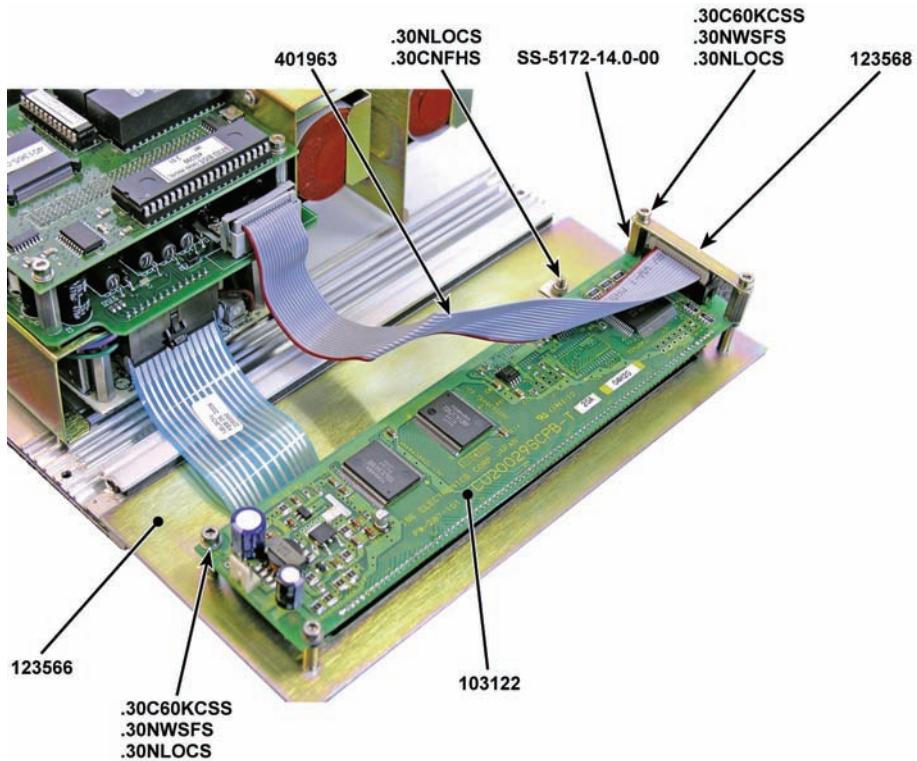

Figure 16. RPM4 Illustrated Parts Breakdown of Rear Panel

**Table 23.** RPM4 Illustrated Parts Breakdown of Display Assembly (see Figure 17)

# REQUIRED	DESCRIPTION	PART NO.
1	Display assembly	103122
1	Ribbon cable	401963
1	Panel, front	123566
2	Standoff, M3	SS-5172-14.0-00
4	Screw, M3	.30C60KCSS
11	Washer	.30NWSFS
5	Lock washer	.30NLOCS
1	Retainer plate	123568
1	Nut, M3	.30CNFHS



**Figure 17.** RPM4 Illustrated Parts Breakdown of Display Assembly

**Table 24.** RPM4 Illustrated Parts Breakdown of Internal Assembly (see Figure 18)

# REQUIRED	DESCRIPTION	PART NO.
1	Bracket, barometer	123549
1	Barometer assembly	401898-06
1	Cable assembly, barometer	401966
8	Screw	.30C60KCSS
14	Lock washer	.30NLOCS
6	Screw	122037-Z
1	Adaptor	APCR206CR16WN
1	Tubing, vinyl	APO2PV170
1	Tubing, polyurethane	3814-7-BK-RL
1	Ferrite sleeve	ZCAT1518-0730T
1	Electronic chassis	123565
5	Nut	123707
5	Screw	100550-Z

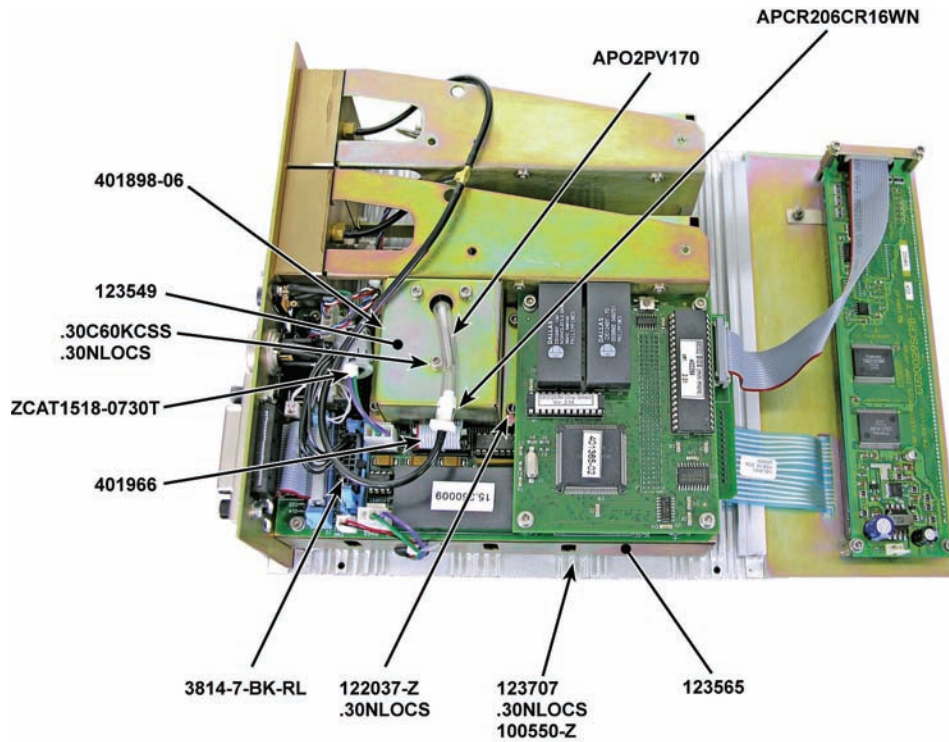

**Figure 18.** RPM4 Illustrated Parts Breakdown of Internal Assembly

**Table 25.** RPM4 Illustrated Parts Breakdown of Internal Assembly (see Figure 19)

# REQUIRED	DESCRIPTION	PART NO.
1	Manifold, A20M	123521
1	Manifold, A70M	124410
14	Screw, M3	.30C60KCSS
14	Lock washer, M3	.30NLOCS
4	o-ring, 5-193	5-193-V884-75
2	Bracket, transducer	123583
2	Cowling, transducer	123511
2	Transducer	807029
1	Tee	209-1
2	Union	SS-100-6
2	Adaptor, ss	SS-100-1-0S
2	Adaptor, barb	MH-1012-V
1	Plug, ss	124411

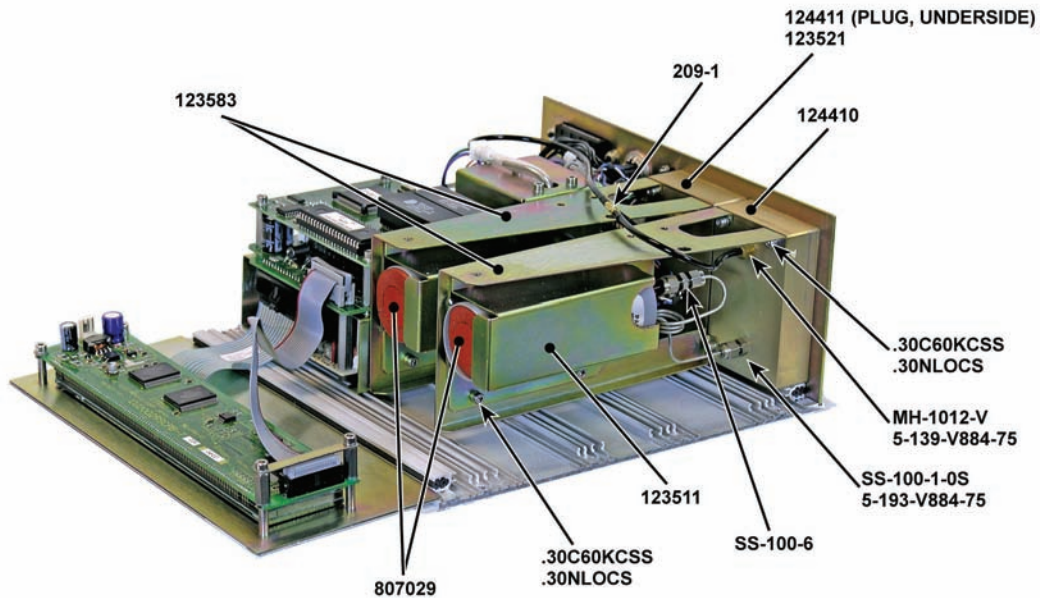

**Figure 19.** RPM4 Illustrated Parts Breakdown of Internal Assembly

**Table 26.** RPM4 Illustrated Parts Breakdown of Electronic Chassis (see Figure 20)

# REQUIRED	DESCRIPTION	PART NO.
1	Micro card	401365
4	Standoff	SS-5172-200-00
10	Screw	.30C80KCSS
11	Lock washer	.30NLOCS
1	Driver board	401745
1	Power supply	103284
4	Standoff	.30C300SFTS
4	Washer	.30NWSFS
1	Cable assembly, DC power	401962
1	Cable assembly, AC power	401964

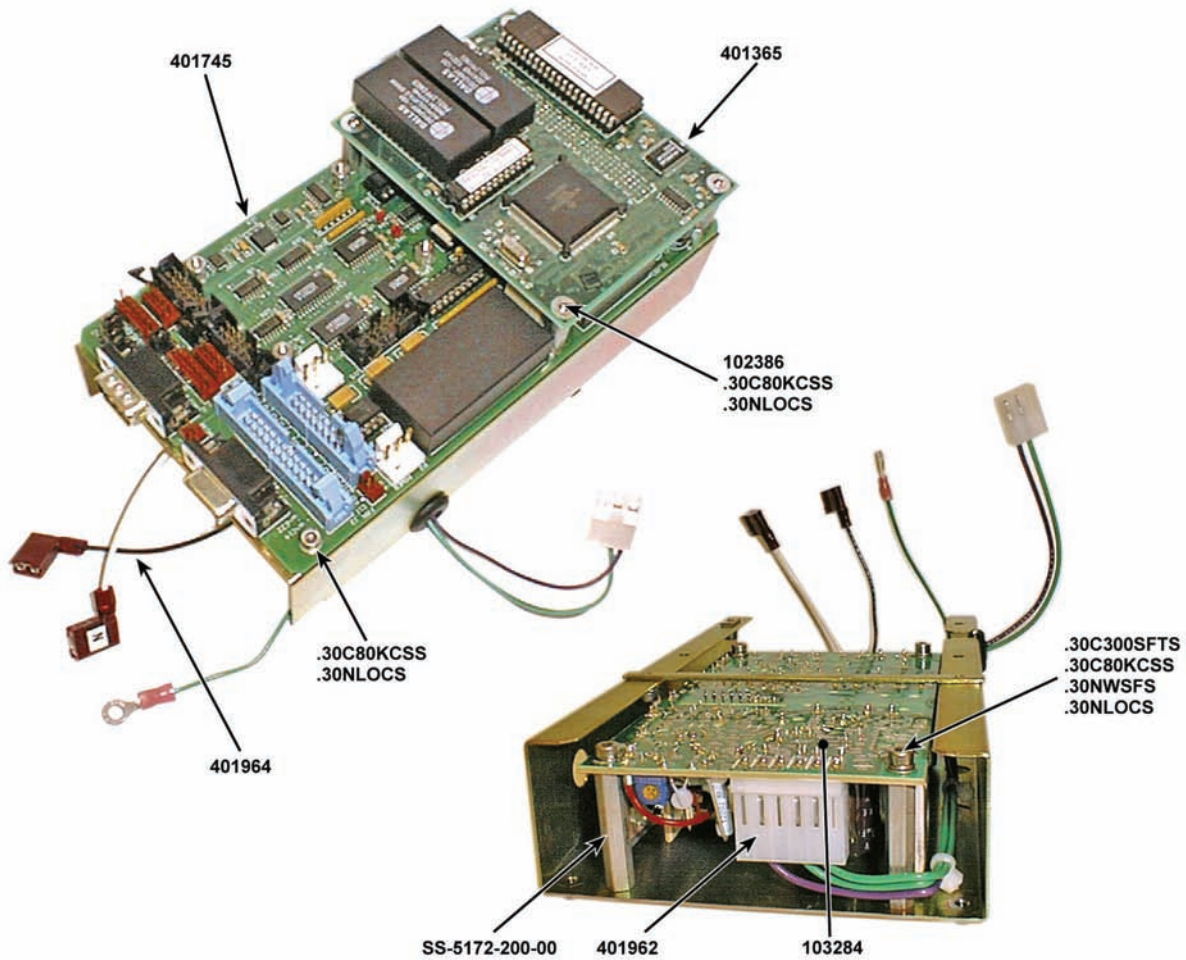

**Figure 20.** RPM4 Illustrated Parts Breakdown of Electronic Chassis

## 5.6 HPMS MAINTENANCE

There are no HPMS maintenance procedures other than the overhaul procedure.

### 5.6.1 HPMS OVERHAUL

RPM4/HPMS A70M/A20M-AF is generally overhauled as one common assembly. Removal of RPM4 from the HPMS is not recommended unless required to perform RPM4 and/or HPMS repairs. See Section 5.4.1 if it is necessary to remove the RPM4 from the HPMS.

Any or all of the following items may be included as part of an RPM4/HPMS A70M/A20M-AF overhaul:

- Check that RPM4 rear panel mounted cooling fan operates when RPM4 is powered.
- Clean and inspect HPMS rear panel **TEST** port connection.
- Check that internal fittings, screws, bolts and nuts are tight.
- Perform system leak and operational check.
- Check Lo Q-RPT pressure relief valve for proper operation. It should crack at about 3 300 psi. **Do not apply pressure greater than 3 600 psi to the RPM4 Lo Q-RPT as it may be damaged beyond repair. The RPM4 warranty does not cover damage due to Q-RPT overpressure.**
- Clean RPM4 and HPMS front panel.
- Verify that RPM4 internal barometer reads atmospheric pressure within  $\pm 0.15$  psi (1 kPa). Adjust if necessary (See Section 5.2.2).
- Perform calibration of quartz reference pressure transducers (Q-RPTs), if necessary (see Section 5.3)

## 5.7 HPMS ILLUSTRATED PARTS BREAKDOWN

**Table 27.** HPMS Assembly Illustrated Parts Breakdown (see Figure 21 and 22)

# REQUIRED	DESCRIPTION	PART NO.
1	HPMS bracket	124142
1	RPM4 mounting bracket, rear	124143
1	RPM4 mounting bracket, side	124155
1	High pressure manual valve	400902-02
1	Valve nut	122039
1	Valve seat	122034
1	Tube weld assembly	124146
1	Tube weld	124147
1	Tee connector	SS-200-3
1	Tube, 248 mm	304-F2-125
1	Tube, 40 mm	304-F2-125
1	Bracket, Relief valve	123118
1	Pressure relief valve	402188
1	DH500 bulkhead	123812-01
1	Foot switch cable assembly (Not Pictured)	402196
1	LED, green	252-122
2	LED, red	252-121
4	Rubber foot pad	2959-405-BLK
1	Adaptor	SS-200-R-4
2	DH200 gland	20-2LM4
2	DH200 collar	20-2L4
1	DH500 gland	60-2HM4
1	DH500 collar	60-2H4-316
2	Adaptor	2CM2-316
14	Lockwasher, M4	.40NLOCS
11	Washer, M4	.40NWSAS
12	Nut, M4	.40CNFHS
2	Screw, M3 x 10	.30C100MXFS
4	Screw, M4 x 10	.40C100KCSS

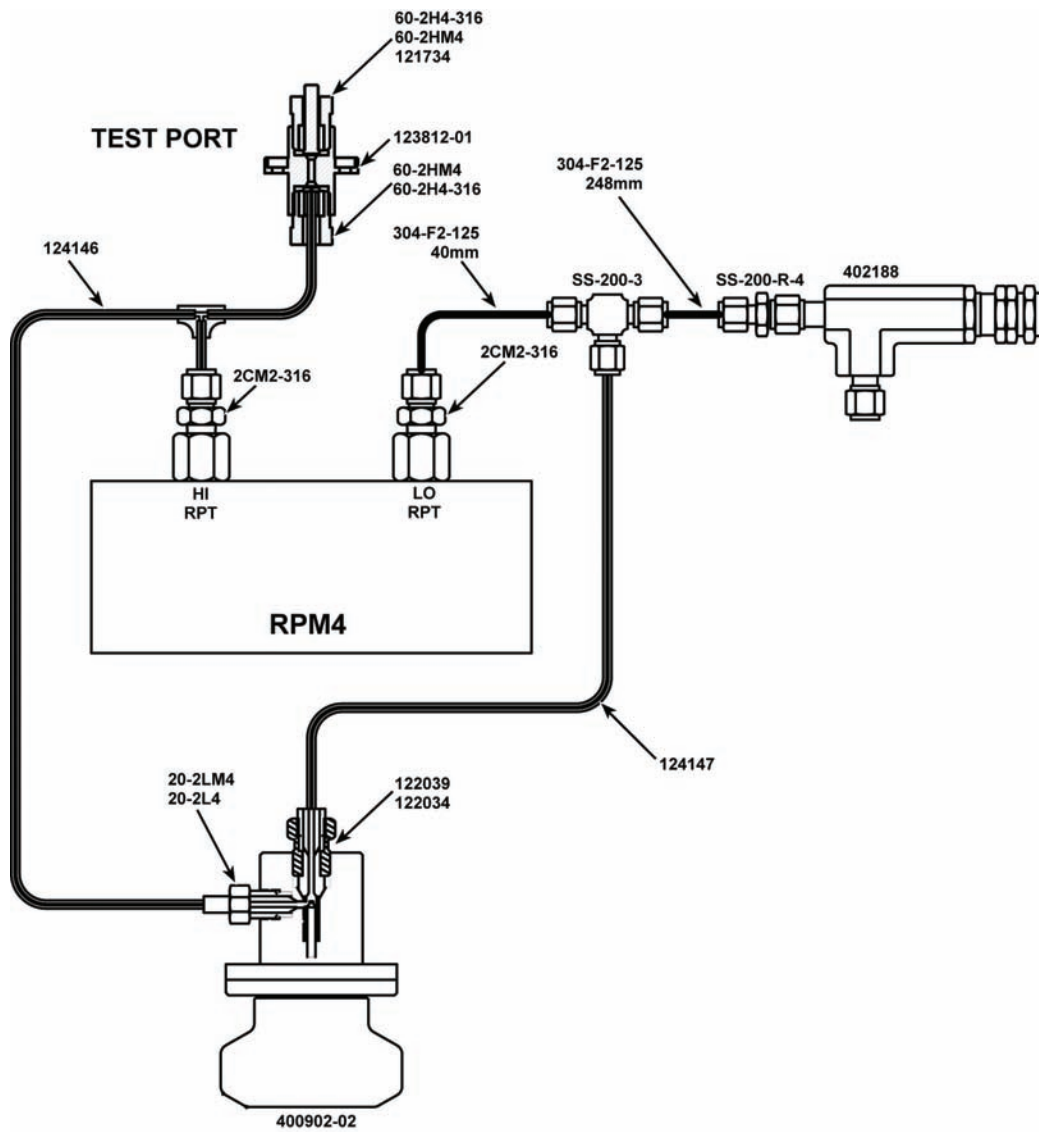

Figure 21. HPMS Schematic



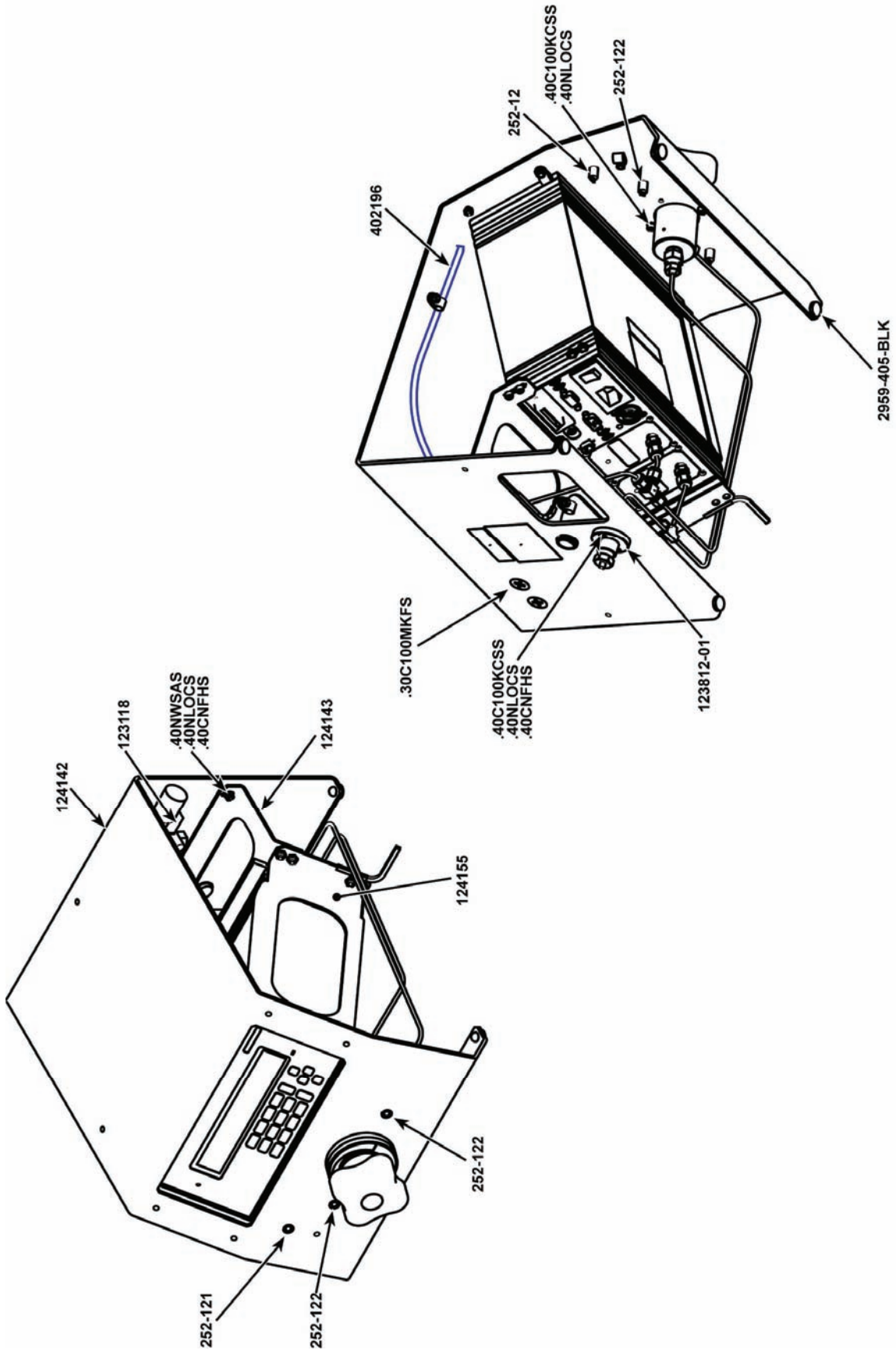

Figure 22. RPM4/HPMS-AF Assembly

## NOTES



## 6. TROUBLESHOOTING

RPM4 is a sophisticated pressure setting and measuring instrument with advanced on-board features and functions. Before assuming that unexpected behavior is caused by a system defect or breakdown, the operator should use this manual and other training facilities to become thoroughly familiar with RPM4 operation. This troubleshooting guide is intended as an aid in identifying the reason for RPM4 behavior and determining whether the behavior is normal operation or due to an internal or external problem.

Identify the symptom or unexpected behavior you are observing from the **SYMPTOM** list below. A **PROBABLE CAUSE** is provided and a **SOLUTION** is proposed including references to manual sections that provide information that may be of assistance.

**Table 28.** Troubleshooting guide

SYMPTOM	PROBABLE CAUSE	SOLUTION
Will not power up.	Blown fuse.	Replace fuse.
Cannot access certain functions > <b>ACCESS RESTRICTED</b> <	User level has been set that restricts access to certain functions.	Change user level or consult system manager. 3.5.5.5
Displays < <b>FATAL ERROR</b> > or < <b>FATAL FAULT</b> >.	Encountered unresolved internal software conflict.	Cycle power to clear. Please record conditions leading up to event including the numbers displayed when <b>[ENT]</b> is pressed and report to your <b>DHI</b> Authorized Service Provider. Table 23
Front panel keys seem to be disabled.	" <b>remote</b> " command has been sent from a host computer.	Send " <b>local</b> " command from host computer or cycle RPM4 power. 4, 4.4.4
Measured pressure display or other displays have too much/not enough resolution.	Resolution setting needs to be changed.	Change resolution setting using the resolution function, using AutoRange or by initializing an AutoTest. 3.4.2, 3.3.4, 3.3.10
Can't increase resolution to level desired in AutoRanged range.	Resolution setting is limited when AutoRanging under 10 % of Q-RPT default range.	Operation is normal. 3.3.4, Table 6
Values that should be non-zero are displayed as zero.	Resolution setting needs to be increased to view significant digits.	Change resolution setting. 3.4.2
Keypad presses make undesired sounds or NO sounds.	Keypad sound settings are incorrect.	Use <b>SOUND</b> function to set keypad sounds as desired. 3.5.5.2
Bottom line of display has changed and you want to change it back.	The <b>DISPLAY</b> function has been used to change the display.	Use <b>[DISPLAY]</b> to set bottom line to desired display. 3.3.6
Bottom line of display is blank.	<b>DISPLAY</b> mode is "clean".	Use <b>[DISPLAY]</b> to change bottom line display if desired. 3.3.6
The pressure units available under the <b>[UNIT]</b> function key are not the ones you want.	<b>UNIT</b> function needs to be customized.	Use <b>PresU</b> function to customize the <b>UNIT</b> function or reset units to default. 3.5.6, 3.5.9.2
Front panel display is dim.	Screen saver option has activated.	Operation is normal. Press any key to resume full screen power. Adjust screen saver time, if desired. 3.5.5.1

SYMPTOM	PROBABLE CAUSE	SOLUTION
AutoRange is not selecting the desired Q-RPT for the specified range.	The Q-RPT range does not cover the specified AutoRange full scale pressure.	Check that Q-RPT default range is high enough to cover the AutoRange. 3.2.3
	The specified operating mode is absolute and absolute is OFF for the desired Q-RPT	Check that absolute measurement mode is ON for the Q-RPT. 5.3.5
Pressure display is flashing and beeper is sounding intermittently.	Current upper limit of active range has been exceeded.	Reduce pressure. Change UL and/or change active range using <b>[RANGE]</b> , <b>[AUTORANGE]</b> or AutoTest. 3.4.4, 3.3.4, 3.3.10
"Hi (or Lo) Q-RPT EXCEEDED PMAX" displays alternating with normal display.	RPM4 Q-RPT has been overpressured (Pmax! exceeded).	Correct the overpressure condition and cycle power ON and OFF to clear. Q-RPT may be damaged! 3.4.4.1
Display is <b>&lt;!!!LO RPT ACTIVE!!!&gt;</b> the HPMS <b>CAUTION LO RPT ACTIVE</b> light is flashing and RPM4 is beeping.	The Lo Q-RPT is receiving pressure but the Hi Q-RPT is currently selected.	Since the Hi Q-RPT is selected on RPM4, the Lo Q-RPT should be shut off by the <b>LO Q-RPT SHUTOFF</b> valve. Reduce pressure and close the <b>LO Q-RPT SHUTOFF</b> valve or select the Lo Q-RPT on the RPM4. Do not apply more than 3 000 (20 MPa) to the Lo Q-RPT. 3.2.5
A <i>Ready</i> (green <i>Ready/Not Ready</i> indicator) indication is never achieved.	Stability settings is too tight and/or existing conditions will not allow <i>Ready</i> to be achieved.	Adjust stability setting or correct other conditions. Consider using an AutoTest to set stability appropriately. 3.4.3, 3.2.1, 3.3.10
Cannot select absolute measurement mode.	Absolute measurement mode has been turned off in the calibration function.	Check that absolute is ON for the Q-RPT. 5.3.5
Display update rate of indicated pressure changes when changing pressure.	RPM4 automated read rate function is ON to automatically adjust read rate depending upon rate of change of pressure.	Operation is normal. Turn automated read rate function OFF if desired. 3.5.7.2
Display update of indicated pressure is too slow when pressure is changing quickly.	RPM4 automated read rate function is OFF.	Turn automated read rate function ON to automatically adjust read rate depending on pressure rate of change. 3.5.7.2
Pressure is changing but display of pressure is NOT and the bottom right hand corner of the display is a numerical countdown followed by <b>&lt;avg&gt;</b> .	Average DISPLAY function is ON and pressure display is updating only with the average value at the end of each averaging cycle.	Go to a DISPLAY function other than average or press <b>[+/-]</b> to get the instantaneous value Average DISPLAY. 3.3.6
Pressure measurement seems erratic.	The RPM4 and/or the connection to the test system and or the GPC1 pressure controller is contaminated with liquids.	Purge and clean affected systems. Contact <b>DHI</b> Authorized Service Provider if RPM4 is contaminated internally. 8, Table 23
Pressure indicated by RPM4 never becomes stable.	These is a leak in the pressure system to which RPM4 is connected.	Find and correct leak. Consider using RPM4 leak check function. 3.3.5
	The pressure applied to the RPM4 has recently been changed and the pressure is still stabilizing.	The time it takes for pressure to stabilize after making a pressure change increases with the size of the pressure change and size of the test volume. Up to five minutes or more can be required for pressure to stabilize within 0.001% of the measured pressure
	The RPM4 display resolution is higher than is necessary and you are observing normal evolution of the pressure ( <b>Note: if viewed with enough resolution, pressure is NEVER perfectly stable</b> ).	Use the resolution setting function, AutoRange or AutoTest to reduce resolution to a level that is appropriate for the test being run or the uncertainty of the device being calibrated. 3.4.2, 3.3.4, 3.3.10
Disagreement between two Q-RPTs in system appears excessive.	Difference is actually within tolerance and acceptable disagreement.	Compare differences observed to tolerances on Q-RPT measurements. 1.2.2.1
Apparent inaccurate pressure control/measure and little or no response from Q-RPT:	Reference transducer destroyed by overpressure.	Contact <b>DHI</b> Authorized Service Provider. 8, Table 23

SYMPTOM	PROBABLE CAUSE	SOLUTION
Apparent inaccurate pressure measurement.	Incorrect pressure units and/or measurement mode (gauge or absolute).	Set desired pressure units and/or measurement mode. Consider reference temperature if unit is inWa. 3.3.2, 3.3.3
	Q-RPT calibration coefficients have been altered.	Check and correct calibration coefficients if needed. 5.3
	AutoZ has been run and turned ON with an incorrect standard for zero.	Check value of $P_{offset}$ . Rerun AutoZ with a valid reference. 3.5.1
Apparent inaccurate pressure measurement and <b>&lt;h&gt;</b> is displayed on top line of screen.	An unplanned "head" correction is active or head height or fluid is incorrect.	Operation is normal. Remove or change "head" correction. 3.3.7
AutoZ was just run in gauge mode but measurement indication is NOT zero. <b>&lt;h&gt;</b> is displayed on top line of screen.	A head correction is applied and current indication is the value of the head.	Operation is normal. 3.3.7, 3.3.9.1, 3.5.1
Pressure applied is zero gauge but reading is NOT zero.	Need to run AutoZ to rezero in gauge mode.	Run AutoZ. 3.3.9.1
	Current measurement mode is absolute and RPM4 is indicating atmospheric pressure.	Check measurement mode setting and set to gauge if gauge pressure measurements are desired. 3.3.3
Pressure applied is atmospheric but RPM4 indicates near zero.	Current measurement mode is gauge and RPM4 is indicating zero gauge pressure.	Check measurement mode setting and set to absolute if absolute pressure measurements are desired. 3.3.3
Is NOT reading pressure applied to the Lo Q-RPT.	HPMS Lo Q-RPT Shut Off Valve is closed shutting off the Lo Q-RPT from the HPMS <b>TEST</b> port.	Familiarize yourself with the HPMS configuration and operation. Open the Lo Q-RPT Shut Off Valve. 3.2.5
Is NOT reading pressure applied to RPM4 <b>TEST</b> port.	RPM4 has two <b>TEST</b> ports and pressure to be measured is connected to correct port but active Q-RPT is NOT the Q-RPT on that <b>TEST</b> port.	Familiarize yourself with your RPM4 configuration. Set active Q-RPT and range to read on desired test port. 2.4.3.2, 3.2.3, 3.3.1
<b>[ENT]</b> is not accessing the AutoTest function.	You are in a Display mode other than Rate that uses the <b>[ENT]</b> key.	Press <b>[DISPLAY]</b> and set the Display mode to Rate. 3.3.6.2

## NOTES



## 7. APPENDIX

### 7.1 UNIT CONVERSION

#### 7.1.1 PRESSURE

RPM4 performs all internal calculations in SI units. Numerical values input or output in other units are converted to SI immediately after entry and back to other units just before output as needed.

Table 28 provides the conversion coefficients used by RPM4 to convert numerical values expressed in SI units to corresponding values expressed in other units.

**Table 29.** Pressure unit of measure conversion coefficients

TO CONVERT FROM Pa To		MULTIPLY BY
Pa	<i>Pascal</i>	1.0
mbar	<i>millibar</i>	1.0 E-02
hPa	<i>hecto Pascal</i>	1.0 E-02
kPa	<i>kilo Pascal</i>	1.0 E-03
bar	<i>Bar</i>	1.0 E-05
mmWa @ 4°C	<i>millimeter of water</i>	1.019716 E-01
mmHg @ 0°C	<i>millimeter of mercury</i>	7.50063 E-03
psi	<i>pound per square inch</i>	1.450377 E-04
psf	<i>pound per square foot</i>	1.007206 E-06
inWa @ 4°C	<i>inch of water</i>	4.014649 E-03
inWa @ 20°C	<i>inch of water</i>	4.021732 E-03
inWa @ 60°F	<i>inch of water</i>	4.018429 E-03
inHg @ 0°C	<i>inch of mercury</i>	2.953 E-04
kcm <sup>2</sup>	<i>kilogram force per centimeter square</i>	1.019716 E-05
user	<i>User</i>	User defined coefficient

## NOTES





## 8. WARRANTY

### 8.1 OVERVIEW

Except to the extent limited or otherwise provided herein, **DH Instruments, a Fluke Company** warrants for one year from purchase, each new product sold by it or one of its authorized distributors, only against defects in workmanship and/or materials under normal service and use. Products which have been changed or altered in any manner from their original design, or which are improperly or defectively installed, serviced or used are not covered by this warranty.

**DH Instruments** and any of its Authorized Service Providers' obligations with respect to this warranty are limited to the repair or replacement of defective products after their inspection and verification of such defects. All products to be considered for repair or replacement are to be returned to **DH Instruments** or its Authorized Service Provider after receiving authorization from **DH Instruments** or its Authorized Service Provider. The purchaser assumes all liability vis a vis third parties in respect of its acts or omissions involving use of the products. In no event shall **DH Instruments** be liable to purchaser for any unforeseeable or indirect damage, it being expressly stated that, for the purpose of this warranty, such indirect damage includes, but is not limited to, loss of production, profits, revenue, or goodwill, even if **DH Instruments** has been advised of the possibility thereof, and regardless of whether such products are used individually or as components in other products.

Items returned to **DHI** under warranty claim but determined to not have a defect covered under warranty or to not have a defect at all are subject to an evaluation and shipping charge as well as applicable repair and/or calibration costs.

The provisions of this warranty and limitation may not be modified in any respect except in writing signed by a duly authorized officer of **DH Instruments**.

The above warranty and the obligations and liability of **DH Instruments** and its Authorized Service Providers exclude any other warranties or liabilities of any kind.

**Table 30. DHI Authorized Service Providers**

DH INSTRUMENTS, A FLUKE COMPANY AUTHORIZED SERVICE PROVIDERS			
COMPANY	ADDRESS	TELEPHONE, FAX & EMAIL	NORMAL SUPPORT REGION
DH Instruments, a Fluke Company	4765 East Beautiful Lane Phoenix AZ 85044-5318 USA	Tel 602.431.9100 Fax 602.431.9559 cal.repair@dhinstruments.com	Worldwide
Minerva Meettechniek B.V.	Chrysantstraat 1 3812 WX Amersfoort the NETHERLANDS	Tel (+31) 33.46.22.000 Fax (+31) 33.46.22.218 <a href="mailto:info@minervaijm.com">info@minervaijm.com</a>	European Union
Ohte Giken, Inc. Technology Center	258-1, Nakadai Kasumigaura-machi, Niihari-Gun, Ibaraki 300-0133	Tel 81/29.840.9111 Fax 81/29.840.9100 tech@ohtegiken.co.jp	Japan/Asia

## NOTES



## 9. GLOSSARY

<b>Axxx</b>	A type of Q-RPT with a built-in vacuum reference that is intrinsically absolute (e.g. A10M). Axxx Q-RPTs support absolute, gauge and negative gauge measurement modes.
<b>Absolute Mode</b>	Measurement mode in which the Q-RPT indicates absolute pressure (difference from vacuum).
<b>Active Q-RPT</b>	The Q-RPT that is currently selected to be displayed on the top line of the RPM4 display. Most function selections affect the active Q-RPT.
<b>AutoRange</b>	A function that optimizes RPM4 measurement and control for a specific, user defined range of operation.
<b>AutoRanged Range</b>	An RPM4 pressure measurement range created using the AutoRange function.
<b>AutoTest or ATest</b>	RPM4 on-board automated testing sequences and their results.
<b>AutoZero or AutoZ</b>	A process by which a Q-RPT and measurement mode is rezeroed (offset) relative to a standard.
<b>Barometer</b>	RPM4's on-board atmospheric pressure measuring sensor. Also referred to as on-board barometer.
<b>BGxxx</b>	A type of Q-RPT that is intrinsically gauge and is capable of operating bi-directionally, above and below atmosphere, through zero. BGxxx Q-RPTs support gauge and negative gauge measurement modes.
<b>Default Range (DF)</b>	A Q-RPT's maximum range that is always available using [RANGE] and cannot be deleted.
<b>Deviation</b>	A DISPLAY function in which the deviation of the current pressure from a target pressure is displayed.
<b>DUT</b>	Device Under Test. The device or devices pneumatically connected to the RPM4 TEST(+) port that the RPM4 is being used to test or calibrate.
<b>Differential mode</b>	Measurement mode in which the measured pressure is the different between the Hi and Lo Q-RPT (Hi – Lo).
<b>FS</b>	Abbreviation of "full scale". The full scale value is the maximum pressure of a measurement range. Limits and specifications are often expressed as % FS. Also see span.
<b>Gxxx</b>	A type of Q-RPT that is intrinsically gauge but only measures pressure greater than atmosphere. Gxxx Q-RPTs support gauge measurement mode only.
<b>Gauge Mode</b>	Measurement mode in which the Q-RPT indicates gauge pressure (difference from atmospheric pressure), but only in the positive direction (above atmosphere).
<b>Head</b>	A difference in height between the RPM4 reference level and the DUT.
<b>HiLo</b>	A DISPLAY function in which the highest and lowest pressure measurements since reset are recorded and displayed.
<b>Hi Q-RPT</b>	The designation of a single Q-RPT in an RPM4, or, if there are two, the one that has the highest full scale default range. This is the A70M (10 000 psi) in the RPM4 A70M/A20M-AF.
<b>HL Q-RPT</b>	The designation of the pseudo Q-RPT that results from the combination of using two Q-RPTs simultaneously in parallel measurement mode.
<b>HPMS</b>	High pressure mounting system: Bracket used to hold the RPM4 and isolate the Lo Q-RPT from the test pressure when it is not in use.
<b>Inactive Q-RPT</b>	In an RPM4 with two Q-RPTs, the Q-RPT that is not currently displayed on the top line of the display. The inactive Q-RPT may be displayed on the second line of the RPM4 display using the Q-RPT DISPLAY function.
<b>Lo Q-RPT</b>	The designation of a the Q-RPT with the lower full scale default range in RPM4s with two Q-RPTs. This is the A20M (3 000 psi) in the RPM4 A70M/A20M –AF.
<b>Measurement Mode</b>	Whether pressure is being measured relative to absolute zero or vacuum (absolute mode) or relative to atmospheric pressure (gauge mode).
<b>Negative gauge or compound gauge</b>	Measurement mode in which the Q-RPT indicates gauge pressure (difference from atmospheric pressure), in both positive and negative directions (above and below atmosphere).

<b>P<sub>offset</sub></b>	The difference between a Q-RPT reading and the AutoZero reference at the time AutoZ is run. Used by the AutoZ function when Auto Z is ON to compensate Q-RPT readings for changes in zero over time.
<b>P<sub>std,0</sub></b>	AutoZero reference value. Value indicated by the device against which the Q-RPT is zeroed by AutoZ.
<b>PA</b>	Pressure adder, used to offset a Q-RPT or barometer to calibrate it.
<b>PM</b>	Pressure multiplier, used to adjust span of a Q-RPT or barometer to calibrate it.
<b>Parallel Measurement Mode</b>	Operating mode of RPM4s with two Q-RPTs in which both Q-RPTs are used to measure together in parallel and the indicated pressure is the average of their readings. This creates a pseudo Q-RPT designated HL.
<b>Pmax!</b>	The maximum pressure limit of a Q-RPT. If the pressure measured by the Q-RPT exceeds Pmax!, an overpressure condition occurs.
<b>PPC3</b>	Pressure controller calibrator manufactured by <b>DHI</b> . RPM4 can be used as an external reference device for a PPC3. PPC3 automates RPM4 pressure control.
<b>Q-RPT (Quartz Reference Pressure Transducer)</b>	The transducer used by RPM4 for low uncertainty pressure measurement. May be designated as Hi, Lo or HL depending on its position and role in the RPM4.  Q-RPTs are designated by a leading A, G or BG (absolute, gauge or bi-directional gauge) followed by three numbers and a letter indicating the maximum range of the Q-RPT in kPa (nnnK) or MPa (nnnM).
<b>Rate</b>	A DISPLAY function in which the rate of change of pressure in pressure unit/second is displayed.
<b>Ready/Not Ready</b>	Front panel LED indication of when the pressure measured by RPM4's active Q-RPT is stable within the stability limit. Leading character of the second line when the inactive Q-RPT is displayed on the second line in Q-RPT DISPLAY mode.
<b>RPT2x</b>	Parallel measurement mode in which both Q-RPTs of an RPM4 with two Q-RPTs are used together and the indicated pressure is the average of their measurements.
<b>SDS (Self Defense System)</b>	A system to protect Q-RPTs from overpressure made up of isolation and vent valves and internal operating logic. SDS is not used in RPM4 A70M/A20M-AF.
<b>Span</b>	The difference between FS and the lowest point in a range. For example, the span of a 100 kPa FS range in negative gauge mode is nominally 200 kPa (from - 100 kPa to 100 kPa).
<b>Stability Limit</b>	A limit expressed in units of pressure per second (e.g., kPa/second). The stability limit is used as the <i>Ready/Not Ready</i> criterion. <i>Ready</i> if rate of change is less than stability limit. <i>Not Ready</i> if rate of change is greater than stability limit.
<b>Target</b>	The value from which deviations are measured in the Deviation DISPLAY function.
<b>UL (Upper Limit)</b>	A user settable maximum pressure limit. When pressure exceeds UL, RPM4 beeps intermittently. In negative gauge measurement mode, there is also a user settable lower limit.
<b>User Level</b>	Levels of security that can be set to protect certain RPM4 functions from being accessed.
<b>QDUT</b>	On-board automated test sequence that AutoRanges RPM4 based on characteristics of the Device Under Test (DUT).